

ATM3202

Extreme Low Power Bluetooth 5.0 SoC with Embedded Flash and Energy Harvesting



Datasheet

Overview

The ATM3202 is part of a family of extreme low-power Bluetooth® 5 system-on-a-chip (SoC) solutions. This Bluetooth Low Energy SoC integrates a Bluetooth 5.0 compliant radio with ARM® Cortex® M0 application processor, 128 KB, 512 KB or 1 MB embedded Flash, 128 KB Random Access Memory (RAM), 256 KB Read Only Memory (ROM), 4 KB One-Time-Programmable (OTP) memory, and state-of-the-art power management.

Support for low duty cycle operation allows systems to run for significantly longer time periods without battery replacement. In addition, this series of SoCs from Atmosic supports operation from various energy harvesting sources, including RF, Photovoltaic, TEG (Thermoelectric generator), and motion. Innovative wake-up mechanisms are supported in order to provide options for further power consumption reduction.

The ATM3202 is available in a 40-pin 5 mm x 5 mm QFN package.

Applications

Industrial and Enterprise

- Beacons and Sensors
- Asset Tracking
- Environmental Monitors

Healthcare

- Thermometers
- Asset Trackers
- Patient Monitoring

Home

- Home Automation
- Remote Control
- Human Interface Devices (HID)

Personal

- Wearables

Auto

- Key fobs and Accessories

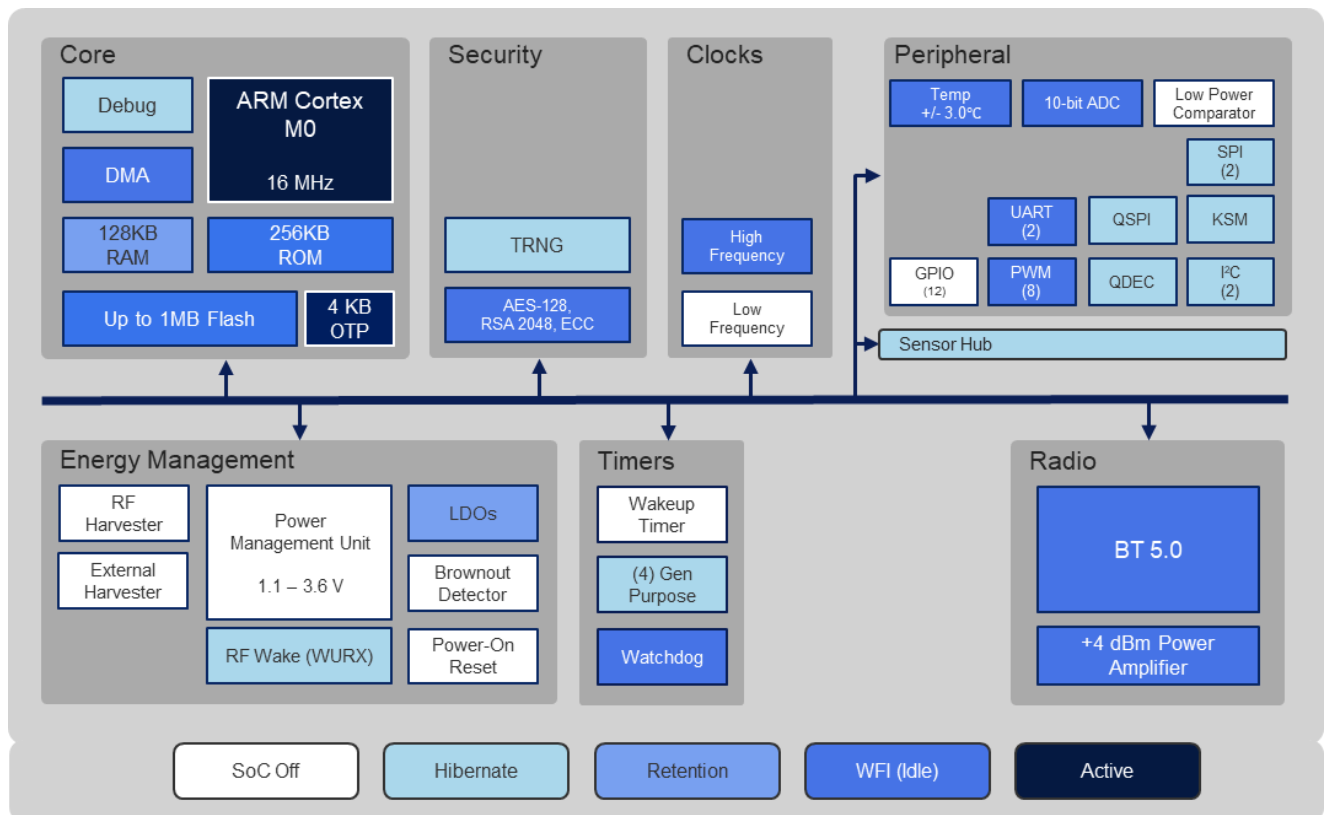

ATM3202 Datasheet

Features

- On-chip RF Energy Harvesting with dedicated antenna input
- Supports Photovoltaic, Thermal, Motion and other energy harvesting technologies
- Compliant with Bluetooth 5.0 standard
- Supports Bluetooth 2 Mbps, 1 Mbps, 500 kbps, and 125 kbps
- Fully integrated RF front-end
- SoC typical power consumption with 3 V battery including PMU
 - **Active Rx @ -95 dBm: 1.0 mA**
 - **Active Tx @ 0 dBm: 2.5 mA**
 - **Retention @ 32 KB RAM: 2 μ A**
 - **Hibernation with Wakeup Receiver: 0.95 μ A**
 - **Hibernate: 0.8 μ A**
 - **SoC Off with Harvesting Enabled: 500 nA**
- CPU: 16 MHz ARM Cortex M0 processor, programmable interrupt router
- Memory: 1 MB embedded Flash, 256 KB ROM, 128 KB RAM, and 4 KB OTP
- Retention RAM configuration: 16 KB to 128 KB in 16 KB step sizes
- RF Wakeup Receiver
- Interfaces: I2C, SPI, UART, PWM, GPIO
- 10-bit application ADC
- Digital microphone input (PDM)
- 16 MHz / optional 32.768 kHz crystal oscillator
- SWD for interactive debugging
- AES 128 hardware
- True random number generator (TRNG)
- Sensor Hub
- Keyboard Matrix Controller (KSM)
- Quadrature Decoder for mouse input (QDEC)
- 1.1 V to 3.3 V battery input voltage with integrated Power Management Unit (PMU)
- Package: 40-pin 5 mm x 5 mm QFN

Table of Contents

Overview	1
Applications	1
Features	2
Table of Contents	3
List of Figures	4
List of Tables	4
1 Functional Description	5
1.1 CPU & Memory	6
1.1.1 Clocks	7
1.1.2 Reset	8
1.1.3 Power Modes	8
1.2 Security	8
1.3 Power Management	9
1.3.1 PMU Configurations	10
1.4 Sensor Hub	10
1.5 Bluetooth LE Radio	11
1.5.1 Link Controller	11
1.5.2 Modem	11
1.6 Wakeup Receiver	12
1.7 OTP Access	12
1.8 Timers and Interrupts	13
1.8.1 Wakeup Timer	13
1.8.2 General Purpose Timers	13
1.8.3 Interrupts	13
1.9 Pin Multiplexing	13
1.10 Peripherals and I/O	13
2 Electrical Specification	15
3 Signal Description	21
3.1 ATM3202 Pinout	21
4 Mechanical Drawing	23
4.1 ATM3202	24
4.2 Solder Reflow Profile	26
5 Part Ordering	27
Revision History	28

List of Figures

Figure 1-1	Functional Block Diagram
Figure 1.5-1	Bluetooth LE Radio Block Diagram
Figure 1.6-1	Wakeup Receiver Block Diagram
Figure 3.1-1	ATM3202 40-Pin 5x5 mm QFN Pinout (Top View)
Figure 4.1-1	ATM3202 40-Pin 5x5 mm QFN Mechanical Drawing
Figure 4.1-2	ATM3202 40-Pin 5x5 mm QFN Land Pattern

List of Tables

Table 1.1-1	System Memory Map
Table 1.3-1	PMU External Pins
Table 2-1	Maximum Electrical Ratings
Table 2-2	Recommended Operating Conditions
Table 2-3	Radio Transceiver Characteristics
Table 2-4	Wakeup Receiver Characteristics
Table 2-5	PMU Characteristics
Table 2-6	GPIO Characteristics
Table 2-7	Application ADC Electrical Parameters
Table 2-8	Embedded Flash Characteristics
Table 2-9	Power Consumption
Table 2-10	Energy Harvesting
Table 3.1-1	ATM3202 Pin Description
Table 4.1-1	ATM3202 40-Pin 5x5 mm QFN Dimensions
Table 4.1-2	ATM3202 40-Pin 5x5 mm QFN Land Pattern Dimensions
Table 5-1	Part Ordering Numbers

1 Functional Description

Figure 1-1 Functional Block Diagram

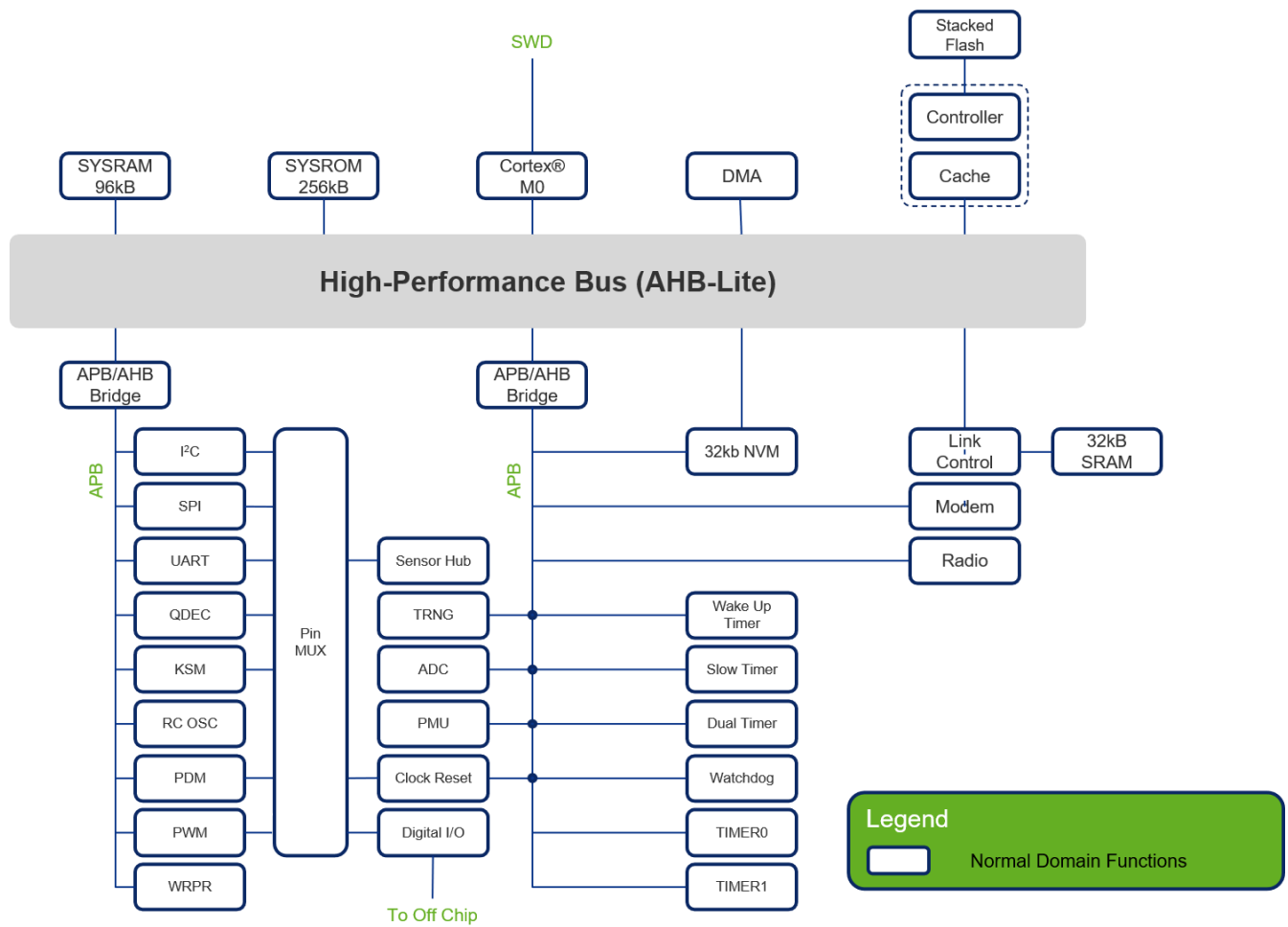

ATM3202 Datasheet

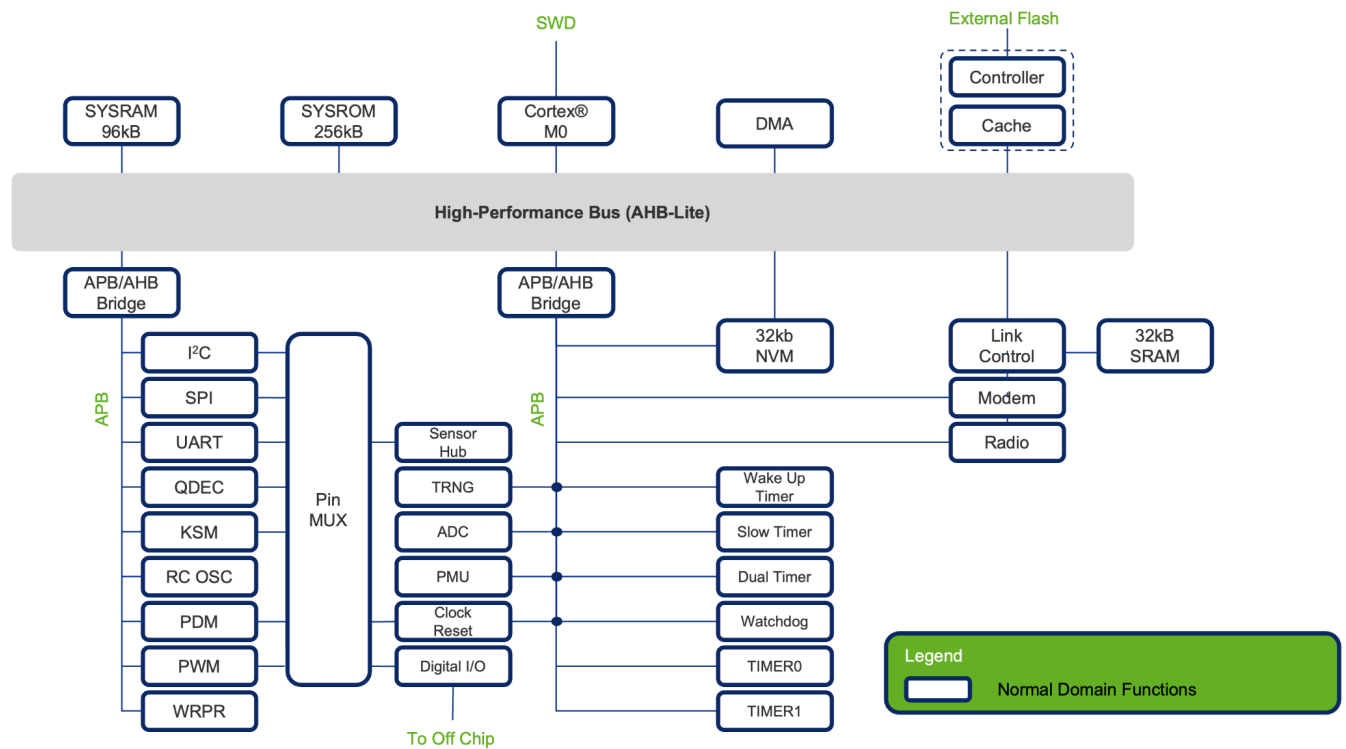

1.1 CPU & Memory

The ATM3202 contains a 16 MHz 32-bit ARM® Cortex®-M0 processor that is optimized for low-power operation. The processor is a little endian, 32-bit RISC processor which implements the ARMv6-M architecture specification. It supports most Thumb-1 instructions and some Thumb-2 instructions. It features four breakpoints, a serial access debug port, 32 interrupts, a single cycle multiplier, full wake-on-interrupt support, and two watch points.

To reduce latency, software can use the Direct Memory Access (DMA) core for memory to memory copying and for initializing blocks of memory to a constant. When it is in use, the DMA core masters the Advanced Microcontroller Bus Architecture (AMBA) High-performance Bus (AHB) and has higher precedence than the Cortex®-M0.

The ATM3202 includes the following memory components:

- ROM: 256 KB of ROM containing the Bluetooth LE 5 protocol stack up to GATT/GAP layer, a beacon application, and the boot code
- SRAM: 128 KB of SRAM containing both system RAM and data RAM organized as eight 16 KB macros. Two of the macros are reserved for the Bluetooth 5 link controller. The power state of each macro in each low power state can be independently controlled
- NVM: 4 KB of One-Time-Programmable memory (OTP) to store configuration, calibration data, and user data
- FLASH: 128 KB, 512 KB or 1 MB embedded flash for customer applications

There is one quad SPI (QSPI) master port connected to the embedded flash and supports up to 32 MHz. Internally there are three cores that can act as master for the interface:

(a) 1-bit core identical to the SPI core described in the [Peripherals and I/O](#) section. It provides read and write support to the external flash via indirect addressing.

ATM3202 Datasheet

(b) Software specified protocol / content. The hardware's role is limited to serial shift in or out. Read and write access via indirect addressing is provided by this core.

(c) Direct memory mapping of the entire external flash contents. It essentially acts as an AHB bridge to the external flash. The hardware handles all protocols. Additionally, this core contains a cache in the read direction to reduce latency.

The quad SPI master port is equipped with a cache in the read direction to reduce the effective latency of flash accesses. Performance operating out of flash is comparable to that of operating out of RAM. When executing out of RAM and at 16 MHz, the ATM3 has a CoreMark 1.0 score of 29.5. When executing out of embedded flash, with the quad SPI interface boosted to 32 MHz, the quad SPI cache enabled, and the remainder of the SoC operating at 16 MHz, the ATM3 has a CoreMark 1.0 score of 25.7. Pins P1 and P2 can be used to access the Cortex®-M0's serial wire debug (SWD) port. The on-chip system memory is organized as follows:

Table 1.1-1 System Memory Map

Start	Stop	Block
0x0000 0000	0x0003 FFFF	ROM
0x1000 0000	0x100F FFFF	FLASH
0x2000 0000	0x2001 7FFF	SRAM
0x3000 0000	0x3000 FFFF	Link Controller
0x4000 0000	0x4000 FFFF	APB0_Peripherals
0x4001 0000	0x4001 1FFF	GPIO
0x4001 F000	0x4001 FFFF	SYSCTL
0x5000 0000	0x5000 FFFF	APB1_Peripherals
0x6000 0000	0x6000 0FFF	NVM
0x7000 0000	0x7000 0FFF	DMA
0x8000 0000	0x8000 0FFF	PDM

1.1.1 Clocks

There are three primary clock domains on the ATM3202:

- low power clock: 32.768 kHz crystal or an internal RC oscillator (RCOSC)
- medium power clock: 16 MHz crystal or an internal RC oscillator (RCOSC)
- high power clock: used by quad SPI for embedded flash

ATM3202 Datasheet

1.1.2 Reset

The PMU releases the chip-wide reset once the power supplies have stabilized. There is no explicit reset pin on the ATM3202 but the user can use PWD for an equivalent purpose. Many of the internal modules can additionally be reset through a software register write.

1.1.3 Power Modes

The SoC supports five primary power states which are Active, Retention, Hibernation, SoC Off, and Powerdown. Each primary state may have several secondary states depending on the number of active power domains and clock gating.

1. Active: All regions of the SoC are powered on. Active power can be optimized by utilizing clock gating registers and/or by putting the Cortex-M0 into Wait for Interrupt (WFI).
 - CPU Idle: When the CPU function is not required, it can be placed into WFI state to conserve power.
 - Bluetooth LE Deep Sleep: Bluetooth subsystem is powered down while the remainder of the ATM3 is powered up. This state is useful when data needs to be processed but does not need to be transmitted over RF.
2. Retention: All or some of the 128 kB SRAM, in increments of 16 kB, can be retained. All register/flip-flop states are retained. Digital I/Os will hold the state they were at when the transition into either Hibernate or Retain started. Wake can be from a timer expiring, activity detected on GPIOs, activity detected on the keyboard, activity detected on the mouse, the sensor hub reading measurements crossing a threshold, and the detection of a connection over the SWD interface. All selections about how to wake need to be programmed before the transition into the low power state is triggered. The SRAM supply voltage can be lowered to further reduce leakage power consumption.
3. Hibernation: Powers down system memory. Retains only a minimal amount of flip-flop state. Retains I/O state. Wake up setting must be programmed before transitioning into this state.
4. SoC Off: all digital domains including the top level digital domain are powered down, but the PMU remains on in an ultra low-power state with limited functionality. The system must do a complete, cold start reboot when returning from this state to an active state. Wake mechanisms are limited to (a) special 40-bit timer, (b) external digital input on P10, (c) ultra-low power analog comparator with input on P11.
5. Powerdown¹ (PWD pin asserted): All power domains including the PMU are completely shut off. No supplies are internally generated or maintained. This state is only valid with an external I/O supply.

1.2 Security

The ATM3202 has a true random number generator (TRNG) which generates a single 32 bit random number per invocation. Arbitrarily long random numbers can be achieved by repeatedly invoking this random number generator. The outputs of TRNG can be used to generate public and private keys which in turn can be used to generate the link layer symmetrical key.

The ATM3202 also has an AES-128 hardware accelerator. This core is directly accessible by software and it is also used by the hardware to encrypt and decrypt packets when needed during Bluetooth LE operation.

If necessary a fuse within the OTP can be set to disable all slave interfaces. This would prevent keys being read out by a third party but it would also disable the SWD interface which in turn blocks future debug. Setting this disabling fuse should be used with caution. Alternatively, writes to the OTP can be permanently blocked. This mechanism would prevent the alteration of public keys but would not block the SWD interface.

¹ Minimum PWD assertion time is 100 μ s.

ATM3202 Datasheet

1.3 Power Management

The power management unit provides the core and I/O power supplies to the ATM3202 SoC. Harvested energy can extend the battery life or enable operation without a battery for some low duty-cycle applications. PMU generates the three power supply outputs: DVDD1P, AVDD1P, VDDIOP, and a fourth auxiliary supply VAUX used internally by the PMU. The following connections must be made on the board:

- DVDD1P to DVDD1
- AVDD1P to VDD1A

Table 1.3 -1 PMU External Pins

PIN	Description
VBAT	Battery input. Battery voltages from 1.1 V to 3.3 V can be used. Must be connected to a battery, external supply, or ground (battery-free applications).
VSTORE	Connection to a large storage capacitor (typical value 220 μ F). Must be grounded when the harvester is not used.
HARV_OUT	Connection to a storage capacitor of typical value 10 μ F. Must be grounded when the harvester is not used.
LEXT1, LEXT2	Terminals between which the switching regulator inductor is connected.
DVDD1P, AVDD1P VDDIOP	DVDD1P and AVDD1P are PMU generated digital and analog core supply outputs. VDDIOP is a PMU generated 1.8 V I/O supply output.
VAUX	Auxiliary supply output of typical value 3.2 V, used internally by the PMU.
DVDD1, VDD1A	Power supply input for digital and analog core circuits.
VDDIO, VDDIOA	Power supply input for digital and analog I/O circuits.

The PMU provides multiple brownout interrupts to enable more reliable operation, especially when using energy harvesting.

ATM3202 Datasheet

1.3.1 PMU Configurations

The PMU must be configured correctly to ensure correct operation. The following modes of operation are supported by the PMU:

(a) One external power supply or battery with external I/O supply:

For applications that cannot support fixed 1.8 V I/O supply

- Connect VBAT to VDDIO/VDDIOA
- Connect VAUX to VDDIOP
- Disable I/O supply generation

(b) One external power supply or battery with internally generated I/O supply:

For applications that can use a fixed 1.8 V I/O supply for better power consumption or $V_{BAT} \leq 1.8\text{ V}$

- Connect VDDIOP to VDDIO/VDDIOA

(c) Energy harvesting with no battery and internally generated I/O supply:

- Connect VBAT to ground
- Connect VDDIOP to VDDIO/VDDIOA

1.4 Sensor Hub

The sensor hub is a hardware module that, when suitably programmed, can read data from external sensors and write to embedded flash on the quad SPI interface. This function can be performed with all other power domains, including the CPU power domain, powered down. Additionally, the sensor hub can trigger a chip wide wake up if any of the read data crosses preprogrammed thresholds.

ATM3202 Datasheet

1.5 Bluetooth LE Radio

The block diagram of the low-power radio is shown in [Figure 1.5-1](#). The radio supports Bluetooth 5.0 including 1 Mbps basic PHY, 2 Mbps high-speed PHY, 500 kbps, and 125 kbps PHY. The basic 1 Mbps PHY is compatible with Bluetooth 4.0, while the 2 Mbps rate provides 2X speed and the long range rates provide up to 4X range. The transmit path uses digital direct frequency modulation of a fractional-N synthesizer to create a constant amplitude GFSK signal that is amplified by a power amplifier to provide the desired RF output level. On the receive path, an incoming RF signal is first amplified by an LNA before downconversion to baseband and digitized by two successive-approximation analog-to-digital converters. The digitized signal is sent to the Modem for further digital processing. The radio architecture is optimized for burst data transmission using Frequency-Hopping Spread Spectrum (FHSS) with 40 channels with 2 MHz spacing (3 advertising channels/37 data channels). Only a single RF Input/Output pin is needed, thereby simplifying board-level design.

Figure 1.5-1 Bluetooth LE Radio Block Diagram

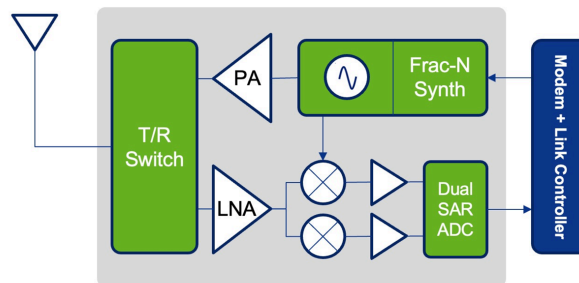

1.5.1 Link Controller

The Bluetooth 5 link controller (LC) and host stack provides an interface between the microcontroller (MCU), modem (MDM) and exchange memory (EM), allowing the MCU to access through the AHB bus to the control registers and exchange memory. During transmission, software writes the packet payload and control structures into the exchange memory. The link controller serializes the data into a bit stream to the modem. During receive, the operation is reversed. Received data from the modem is processed and stored in the exchange memory to be read by software. The design runs on an 8 MHz clock and is synchronous to MDM (16 MHz) and AHB bus (16 MHz) and exchange memory (16 MHz).

1.5.2 Modem

The modem (MDM), along with the radio, link controller, and software stack, forms a highly efficient Bluetooth 5 solution. Transmission and reception at rates of 2 Mbps, 1 Mbps, 500 kbps, and 125 kbps are supported. During receive operation, the modem and radio are enabled prior to expected packet reception as determined by the link controller. Incoming packets are detected, tracked, processed, and then forwarded to the link controller. The modem and radio receiver are turned off by the link controller at the end of a completed packet. Channel information is provided directly from the link controller to the radio without involvement of the modem. There is minimal involvement of the modem in the transmit process. The link controller provides the symbol bit stream, which is then shaped consistent with the GFSK requirements to provide a frequency deviation for the radio. Channel information and target transmit power are provided directly from the link controller to the radio.

ATM3202 Datasheet

1.6 Wakeup Receiver

Figure 1.6-1 Wakeup Receiver Block Diagram

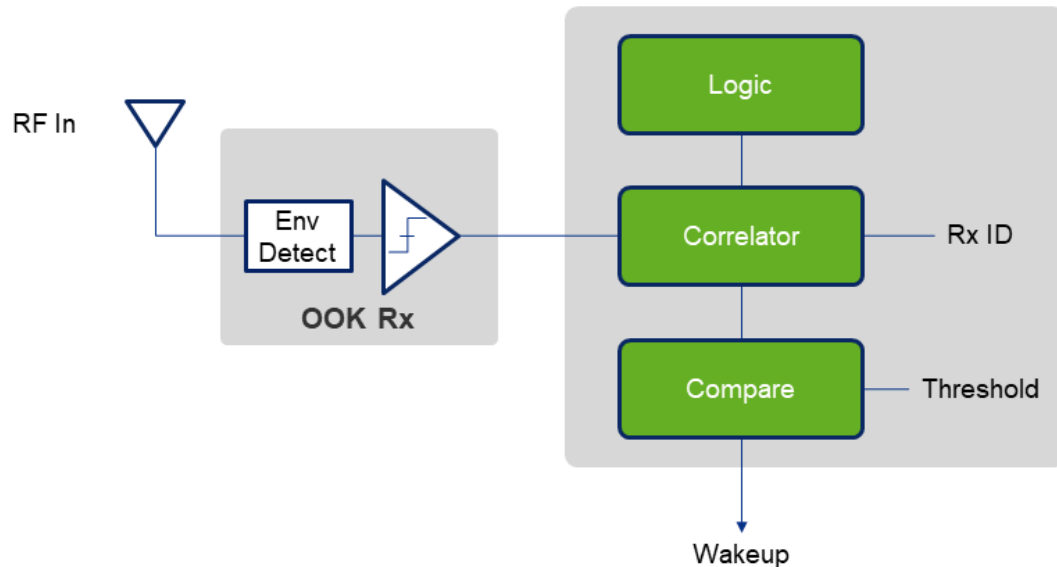

The use of a wakeup receiver allows a system to be in sleep mode while waiting for incoming RF activities. In this SoC, the wakeup receiver is designed to decode an incoming RF paging or wakeup signal with very low power consumption. This dedicated low-power wakeup receiver continuously monitors the incoming RF signal for a predefined paging signal. This continuous Rx mode is based on an OOK radio, which has ultra-low power consumption. The wakeup receiver is intended for short range and short latency applications. Latency of the wakeup receiver is typically in the order of 10 ms to 1 s, depending on the length of the Rx ID code used to identify the target device.

1.7 OTP Access

The OTP is accessible through two separate cores. One resides on the Advanced Peripheral Bus (APB) and provides indirect access for byte reads and bit writes. The other resides on the AHB bus and provides memory mapped addresses for byte, half word, and word reads.

1.8 Timers and Interrupts

1.8.1 Wakeup Timer

Wakeup timer is a 40-bit timer based on the low power 32 kHz clock. When this timer is enabled during SoC Off mode, it will determine the SoC Off duration.

1.8.2 General Purpose Timers

There are four general purpose timer cores: Timer0, Timer1, Dual Timer, and Slow Timer. The value of the timers are readable by the CPU. All timers are clocked by the medium power clock except for the Slow Timer which uses the low power clock. All these timers stop when the system enters a low power mode. The state of the timer is maintained during Retention mode but is reset during hibernate mode.

- Timer0, if enabled, will decrement from a 32 bit reload value to 0 triggering a maskable interrupt as it transitions from 1 to 0. The reload value is loaded as the next timer value when the timer reaches 0.
- Timer1 is identical to Timer0.
- Dual Timer contains two timers and each timer is independent of the other but sharing a single interrupt output. Each timer counts down and can run in one-shot, periodic, or free running mode. The timers are configurable to be either 16 bit or 32 bit. Additionally there is a rescale in front of each timer that can reduce the incoming clock by 1x (no change), 16x, or 256x.
- Slow Timer is a 40 bit count down timer with three programmable thresholds. The interrupt is optionally asserted when the counter counts from one above the threshold to the threshold. It is recommended that the timer be read twice and the value used only if the values from both reads are the same. If the values are not the same then the read should happen a third time. The timer is updating every 16000000/32768 cycles or approximately 488 cycles of the 16 MHz medium power clock.

1.8.3 Interrupts

There is one non-maskable interrupt and it is the watchdog interrupt. There are 32 possible maskable interrupts of which 16 are connected to the GPIO interrupts and 16 are the programmable combination of 48 possible interrupt sources. Each of these 16 configurable interrupts has its own combining function.

1.9 Pin Multiplexing

The ATM3202 supports 12 programmable pins. In addition, each of these I/O pins can be configured to be input only, output only, input/output, with or without pull-up.

1.10 Peripherals and I/O

The following peripherals are supported by the SoC.

- **GPIO**
There are up to 12 GPIOs in the ATM3202. In addition to providing general purpose read and write access, the GPIOs can also be used to generate interrupts and to wake the ATM3202 from low power states.
- **I2C**
There are two identical I2C masters. Software preloads the transaction and then initiates the hardware controller. Software can either poll for completion or respond to the completion interrupt. I2C clock speed is programmable and ranges from 3.9 kHz to 4 MHz.

ATM3202 Datasheet

- **Serial Peripheral Interface (SPI)**

There are two general purpose 1-bit SPI masters. Software can preload the transaction, initiate it, and then either poll for completion or respond to the completion interrupt. Opcode, transaction type, data, and number of bytes are all software programmable. The hardware will serialize and sample incoming data as required by the protocol. The SPI port clock frequency is programmable and ranges from 7.8 kHz to 8 MHz.
- **UART**

There are two UART cores with flow control present on the ATM3202. UART0 should be used for HCI type applications and UART1 primarily for debug messaging (without flow control).
- **PDM Digital microphone**

PDM (Pulse Density Modulation) provides microphone support using two pins and supports three clock speeds (500 kHz, 1 MHz, and 2 MHz).
The PDM-to-PCM conversion block takes as input a 1-bit PDM output from a digital microphone and outputs a 16-bit PCM signal at 16 kHz sample rate. The clock frequency to the PDM microphone can be selected to be 500 kHz, 1 MHz, or 2 MHz. The 1-bit PDM signal is filtered through a 3rd order sinc decimation filter to filter out ADC quantization noise. This is followed by a 1st order IIR filter (that can be bypassed) which attenuates any residual DC content. The corner frequency of the IIR filter is programmable. The gain control block has a programmable gain from -30 dB to 30 dB in steps of 0.5 dB. The output bit rate is 16 bit x 16 kHz = 256 kbps.
The output from the PDM core is captured in a FIFO which supports a ping-pong type drain mechanism.
- **PWM**

The PWM has eight independent pulse width modulation output channels. Each channel has frequency and duty cycle options. Additionally, all channels can be started at exactly the same time if synchronization is required. The frequency ranges from 250 kHz to 8 MHz and the duty cycle is tunable in 1/64th steps.
- **Quadrature Decoder for mouse inputs (QDEC)**

The QDEC is a 3-axis (x,y,z) quadrature decoder. Each axis is independent and requires 2 input pins. QDEC continuously updates the internal integrators and their values can be read by software.
- **Keyboard Matrix Controller (KSM)**

The KSM is a keyboard scanner which supports up to 3 rows by 7 columns or 7 rows by 3 columns. Key pressed and key released events can optionally require that the key be pressed or be released across multiple consecutive scans. Up to 12 simultaneous key events can be tracked.
A portion of the KSM can continue to scan during low power states. The key pressed or key released event can also optionally wake the ATM3202 from a low power state. Key events are not lost when the ATM3202 is in a low power state. Key events are packetized and written into a FIFO via the hardware for later reading by the software.
- **Analog Comparator**

A 16-level analog comparator provides an ultra-low power approach to sense an analog input signal from sensors.
- **Application ADC**

10-bit Application ADC with 1 differential input or 3 single-ended inputs. The ADC input can be one of the input pins, internal signals such as temperature or voltage (supply, battery). The selected input signal is digitized by 10-bit ADC at 2 Msps.

2 Electrical Specification

All parameters are based on 3 V supply at 25 °C unless otherwise specified.

Table 2-1 Maximum Electrical Ratings

Maximum Ratings					
Symbol	Parameter	Min	Typ	Max	Unit
VBAT	Battery voltage ²	-0.2		3.6	V
VDDIO	I/O supply	-0.2		3.6	V
VIO	I/O pin (VDDIO > 3.4 V)	-0.2 ³		3.6	V
	I/O pin (VDDIO ≤ 3.4 V)	-0.2 ³		VDDIO+0.2	V
VRF	RF I/O pin			10	dBm
ESD _{HBM}	ESD HBM (Class 2)			2000 ⁴	V
ESD _{CDM}	ESD CDM			500	V
T _{STORE}	Storage Temperature	-40		125	°C

Table 2-2 Recommended Operating Conditions

Recommended Operating Conditions					
Symbol	Parameter	Min	Typ	Max	Unit
VDDIO	I/O supply	1.7	1.8	3.3	V
VBAT	Battery supply	1.1 ⁵		3.3	V
VPP25	OTP Programming Voltage ⁶	2.3	2.5	2.7	V
VIO	I/O pin	-0.2		VDDIO+0.2	V
	Crystal (Tolerance + Stability) - 16.000 MHz	-50		50	ppm
	Crystal (Tolerance + Stability) - 32.768 kHz	-500		500	ppm

² VBAT minimum slew rate is 0.3 V/ms

³ PWD pin can tolerate a minimum voltage of -1.0V. Please refer to the Hardware Design Guide for ATMx2xx for details.

⁴ Pins TMC and PWD are 1250 V

⁵ VBAT minimum supply after boot is 1.0 V

⁶ VPP25 is physically connected to VDDIO. Set VDDIO to within VPP25 range when programming the OTP.

ATM3202 Datasheet

	Internal RC (RCOSC) Frequency - 32.768 kHz ⁷	30.5		35	kHz
TA	Operating (Ambient) Temperature	-40	25	85	°C

Table 2-3 Radio Transceiver Characteristics

Radio Transceiver Characteristics					
Parameter	Conditions	Min	Typ	Max	Unit
Frequency		2.402		2.480	GHz
Rx sensitivity	37-byte packets, clean Tx				
	125 kbps		-101		dBm
	500 kbps		-98.5		dBm
	1 Mbps		-95		dBm
	2 Mbps		-93		dBm
	255-byte packets, dirty Tx				
	125 kbps		-100		dBm
	500 kbps		-96.5		dBm
Tx output power	4, 2, 0, -2, -4, -6, -10, -20	-20		4	dBm
Tx power accuracy			+/- 1.5		dB
Tx spectral mask @ 1M sym/s	2 MHz offset	-20			dBm
	> 3 MHz offset	-30			dBm
Rx Carrier-to-Interferer (LE 1M PHY)	Co-channel interference	21			dB
	Adjacent 1 MHz interference	15			dB
	Adjacent 2 MHz interference	-17			dB
	Adjacent 3 MHz interference	-27			dB
RSSI resolution			1		dB
RSSI accuracy	-90 to -20 dBm		+/- 2		dB

Table 2-4 Wakeup Receiver Characteristics

Wakeup Receiver Characteristics					
Parameter	Conditions	Min	Typ	Max	Unit

⁷ RCOSC at room temperature.

ATM3202 Datasheet

Sensitivity ⁸	915 MHz and 2440 MHz, 14-byte packets at 1 ms interval for 40 ms		-44		dBm
--------------------------	--	--	-----	--	-----

⁸ >= 90% wakeup success rate

ATM3202 Datasheet

Table 2-5 PMU Characteristics

PMU Characteristics					
Parameter	Conditions	Min	Typ	Max	Unit
AVDD1P Output Voltage			1.0		V
DVDD1P Output Voltage			1.0		V
VDDIOP Output Voltage			1.8		V
VAUX Output Voltage			3.2		V

Table 2-6 GPIO Characteristics

GPIO Characteristics					
Parameter	Conditions	Min	Typ	Max	Unit
Input VIH		VDDIO-0.5		VDDIO	V
Input VIL		-0.2		0.2	V
Output VOH	2 mA Load		VDDIO-0.2		V
Output VOL	2 mA Load		0.2		V
Drive Strength - High Drive (P20-P24)	VDDIO = 3.3 V VDDIO = 1.7 V		16		mA
			10		mA
Drive Strength - Standard Drive (all except P20-P24)	VDDIO = 3.3 V VDDIO = 1.7 V		8		mA
			5		mA
Pull-up Resistance	VDDIO = 3.3 V VDDIO = 1.7 V		45		kΩ
			100		kΩ

Table 2.7 Application ADC Characteristics

Application ADC Characteristics					
Parameter	Conditions	Min	Typ	Max	Unit
Resolution			10		bits
Sampling Rate	Without averaging		2		MHz
Temperature measurement accuracy			+/- 5		°C
Voltage measurement gain error			+/- 1		%
Voltage measurement offset error			+/- 2		LSB

ATM3202 Datasheet

Table 2-8 Embedded Flash Characteristics

Embedded Flash Characteristics					
Parameter	Conditions	Min	Typ	Max	Unit
Endurance	Program/Erase	100,000			Cycles
Data Retention			20		Year
Page Program Time			1		ms
Sector Erase Time			100		ms

Table 2-9 Power Consumption

Power Consumption					
VBAT current at 3 V with internally generated I/O supply					
Parameter	Conditions	Min	Typ	Max	Unit
Active RX	Sensitivity at -95 dBm		1		mA
Active TX @ 4 dBm	Output power at 4 dBm		4		mA
Active TX @ 0 dBm	Output power at 0 dBm		2.5		mA
Active TX @ -10 dBm	Output power at -10 dBm		1.4		mA
CPU Active	Executing CoreMark from RAM at 16 MHz		0.4		mA
CPU Idle + Bluetooth LE Deep Sleep			0.2		mA
Powerdown	PWD pin asserted		75		nA
Retention (32 KB RAM)			2		μA
Hibernation			0.8		μA
Hibernation with Wakeup Receiver			0.95		μA
SoC Off with Harvesting Enabled			500		nA

ATM3202 Datasheet

Table 2-10 Energy Harvesting

Symbol	Parameter	Min	Typ	Max	Unit
HARV_OUT	Cold Start Voltage	1.65		3.3	V
	Steady State Regulated Voltage	1.0		3.3	V
	Input Power	30 ⁹		9000 ¹⁰	μW
VSTORE	Voltage			3.3	V
HARV1_IN	RF Input Level (Operation)	-15		9	dBm
	RF Input Level (Cold Start) @ 915 MHz		-9.5		dBm
	Frequency Range	400		2500	MHz

⁹ Battery free configurations only.

¹⁰ Power limit only at 3.3 V.

3 Signal Description

3.1 ATM3202 Pinout

The ATM3202 is packaged in a 40-pin 5x5 mm Quad Flat Package No Leads (QFN). The pin assignment is shown in the pin description table. All pins are on the bottom side of the package.

Figure 3.1-1 ATM3202 40-Pin 5x5 mm QFN Pinout for (Top View)

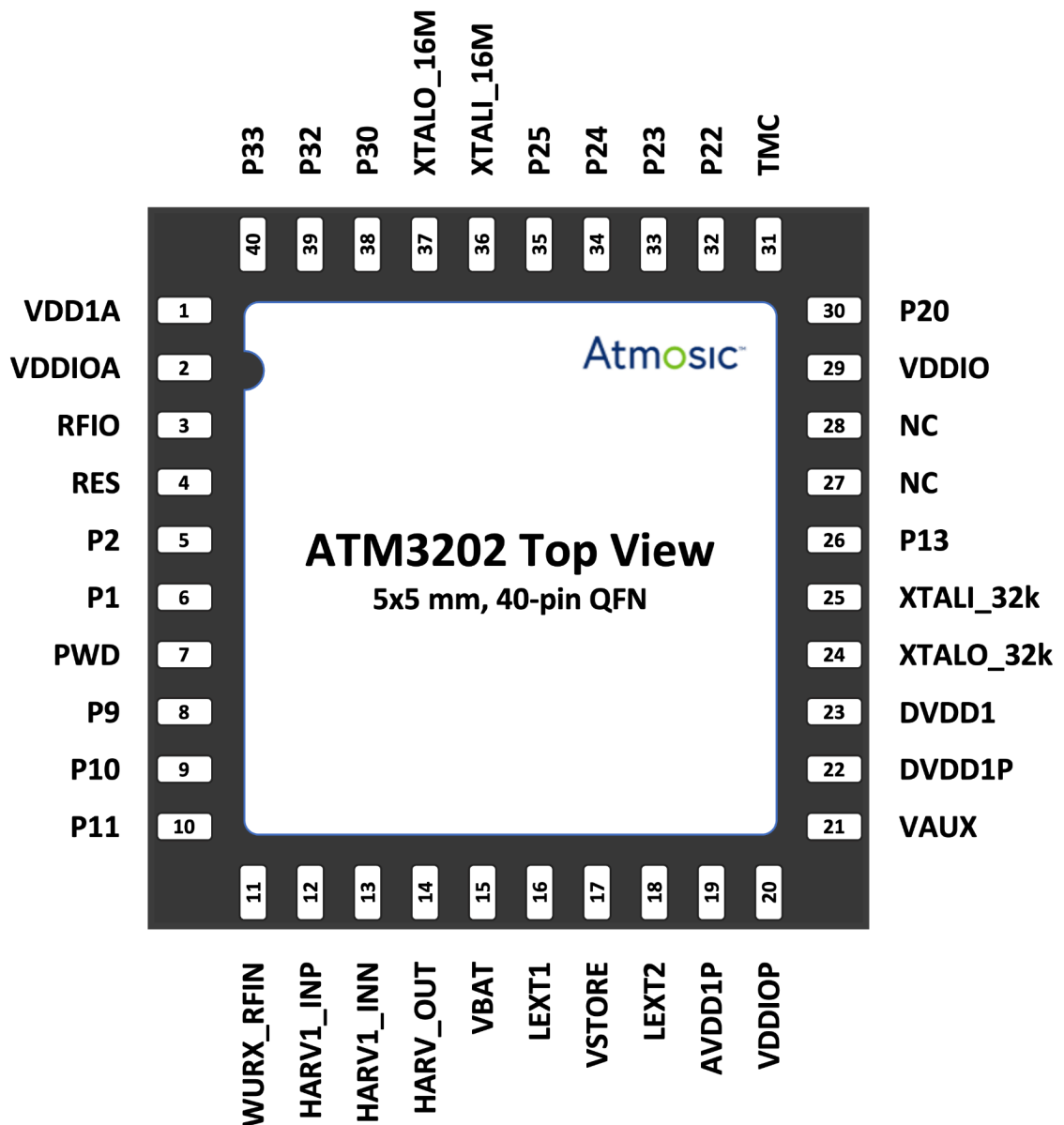

ATM3202 Datasheet

Pin Type Definitions	
Pin Type	Definition
I/O	Signal Input Output
RF	Radio Frequency
PWR	Power supply
A	Analog
R	Reserved
GND	Ground

Table 3.1-1 ATM3202 Pin Description

ATM3202 Pin Description			
Pin Number	Name	Type	Description
1	VDD1A	PWR	Analog and RF core power supply
2	VDDIOA	PWR	Analog and RF I/O power supply
3	RFIO	RF	2.4 GHz Single-ended RF I/O for Bluetooth radio
4	RES	R	Reserved, must tie to ground
5	P2	I/O	Serial wire debug data
6	P1	I/O	Serial wire debug clock
7	PWD	I/O	Power Down Input (Active High)
8	P9	I/O	Programmable Digital or Analog I/O (standard drive)
9	P10	I/O	Programmable Digital or Analog I/O (standard drive)
10	P11	I/O	Programmable Digital or Analog I/O (standard drive)
11	WURX_RFIN	RF	Wakeup receiver RF input
12	HARV1_INP	RF	Differential RF Harvester Input (positive)
13	HARV1_INN	RF	Differential RF Harvester Input (negative)
14	HARV_OUT	A	Output of RF Harvester; can be used as input from other harvesting modalities to supply energy to the ATM chip
15	VBAT	PWR	Battery connection
16	LEXT1	A	Switcher Inductor
17	VSTORE	PWR	Storage node for Switching regulator
18	LEXT2	A	Switcher Inductor
19	AVDD1P	PWR	1 V Analog and RF core power supply generated by switcher
20	VDDIOP	PWR	1.8 V I/O power supply generated by switcher, connect to VAUX if unused
21	VAUX	PWR	Reserved for switching regulator internal use
22	DVDD1P	PWR	1 V Digital core power supply generated by switcher

ATM3202 Datasheet

23	DVDD1	PWR	1 V Digital core power supply
24	XTALO_32k	A	32.768 kHz crystal oscillator output
25	XTALI_32k	A	32.768 kHz crystal oscillator input
26	P13	I/O	Programmable Digital I/O (standard drive)
27	NC	NC	No connection, must be open
28	NC	NC	No connection, must be open
29	VDDIO	PWR	Digital I/O Power Supply
30	P20	I/O	Programmable Digital I/O (high drive)
31	TMC	I/O	VDD_FLASH PWR Flash Power Supply, must tie to VDDIO
32	P22	I/O	Programmable Digital I/O (high drive)
33	P23	I/O	Programmable Digital I/O (high drive)
34	P24	I/O	Programmable Digital I/O (high drive)
35	P25	I/O	Programmable Digital I/O (standard drive)
36	XTALI_16M	A	16 MHz crystal oscillator input
37	XTALO_16M	A	16 MHz crystal oscillator output
38	P30	I/O	Programmable Digital I/O (standard drive)
39	P32	I/O	Programmable Digital I/O (standard drive)
40	P33	I/O	Programmable Digital I/O (standard drive)
EPAD	VSS	GND	Ground supply for all circuits. The 40-pin QFN package has an exposed die pad (E-PAD) at its base. This E-PAD must be soldered to VSS.

ATM3202 Datasheet

4 Mechanical Drawing

4.1 ATM3202

Figure 4.1-1 ATM3202 40-Pin 5x5 mm QFN Mechanical Drawing

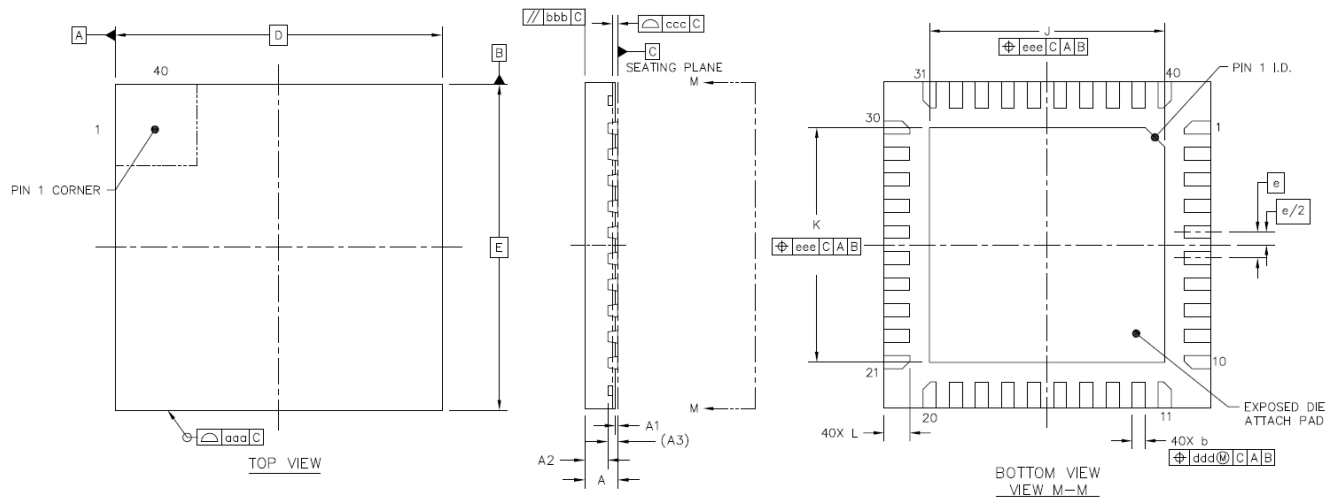

Table 4.1-1 ATM3202 40-Pin 5x5 mm QFN Dimensions

		Symbol	Min	Nom	Max
Total Thickness		A	0.8	0.85	0.9
Stand Off		A1	0	0.035	0.05
Mold Thickness		A2	—	0.65	0.67
L/F Thickness		A3	0.203 REF		
Lead Width		b	0.15	0.2	0.25
Body Size	X	D	5 BSC		
	Y	E	5 BSC		
Lead Pitch		e	0.4 BSC		
EP Size	X	J	3.5	3.6	3.7
	Y	K	3.5	3.6	3.7
Lead Length		L	0.35	0.4	0.45
Package Edge Tolerance		aaa	0.1		
Mold Flatness		bbb	0.1		
Coplanarity		ccc	0.08		
Lead Offset		ddd	0.1		
Exposed Pad Offset		eee	0.1		

Notes:

1. All dimensions are in millimeters.
2. Coplanarity applies to leads, corner leads and die attached pad.

ATM3202 Datasheet

Figure 4.1-2 ATM3202 40-Pin 5x5 mm QFN Land Pattern

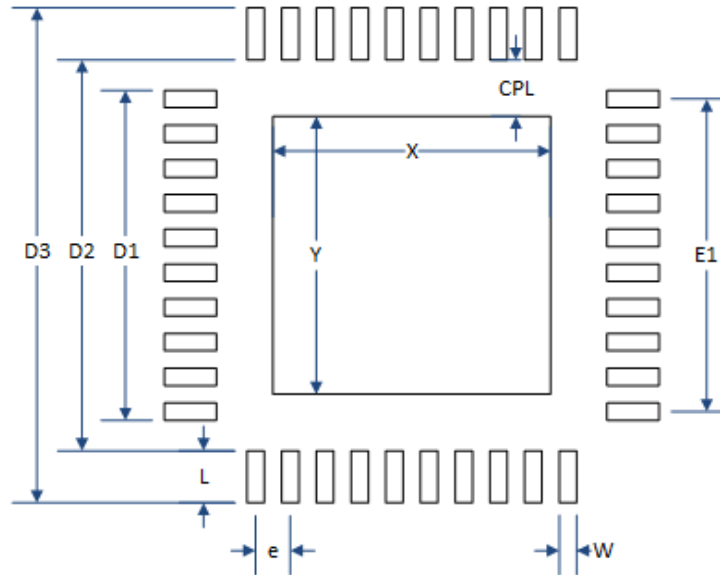

Table 4.1-2 ATM3202 40-Pin 5x5 mm QFN Land Pattern Dimensions

Symbol	Typ
CPL	0.65
D1	3.8
D2	4.5
D3	5.7
e	0.4
E1	3.6
L	0.6
W	0.2
X	3.2
Y	3.2

Notes:

1. All dimensions are in millimeters (mm) unless otherwise noted.
2. The land pattern is based on the IPC-7351 guidelines. There may be other options specified in that publication.
3. The notes above and land pattern are recommendations only. Customers may need to use different parameters as required for their application, materials, SMT process, and tooling requirements.

4.2 Solder Reflow Profile

The recommended reflow profile is per the IPC/JEDEC J-STD-020 specification, for all the packages listed in [Mechanical Drawing](#). Please obtain the official specifications from JEDEC (<https://www.jedec.org/>).

For more information, please contact techdocs@atmosic.com or visit www.atmosic.com

5 Part Ordering

Table 5-1 Part Ordering Numbers

Part Number	Product Line	Description
ATM3202SR	Wireless MCU	5x5 40-Pin QFN ATM3202 Bluetooth 5.0 SoC with 1 MByte embedded flash, Tape and Reel, 7" Small Reel

ATM3202 Datasheet

Revision History

Date	Version	Description
November 22, 2024	1.15	Updated Maximum Electrical Ratings , added footnote on minimum voltage or PWD pin
October 17, 2024	1.14	Added ATM3202 40-Pin 5x5 mm QFN Land Pattern ; Solder Reflow Profile
January 19, 2024	1.13	Corrected typos.
January 12, 2024	1.12	Updated Overview , Features sections, Figure 1-1 Functional Block Diagram , Table 2-2 Recommended Operating Conditions
September 3, 2022	1.11	Updated Part Ordering Numbers .
July 14, 2022	1.10	Updated Part Ordering Numbers .
April 20, 2022	1.00	Updated Application ADC Characteristics , changed format of ATM3202 40-Pin 5x5 mm QFN Pinout for (Top View) pinout diagram, corrected typos.
April 1, 2022	0.56	Changed format, corrected typos.
December 8, 2021	0.55	Updated Table 3-4 Wakeup Receiver Characteristics , Table 3-6 GPIO Characteristics , Table 3-10 Energy Harvesting , Table 4.1-1 ATM3202 Pin Description , 6 Part Ordering sections. Changed format.
July 23, 2021	0.54	Updated pin description of ATM3202 pin P30, P32, P33.
May 27, 2021	0.53	Corrected block diagram
April 12, 2021	0.52	Updated Electrical Specification , Part Ordering sections
December 2, 2020	0.51	Corrected typos
November 7, 2020	0.50	Preliminary version created.



www.Atmosic.com

ATMOSIC TECHNOLOGIES - DISCLAIMER

This product datasheet is intended to be a general informational aid and not a substitute for any literature or labeling accompanying your purchase of the Atmosic product. Atmosic reserves the right to amend its product literature at any time without notice and for any reason, including to improve product design or function. While Atmosic strives to make its datasheets accurate and current, Atmosic makes no warranty or representation that the information contained in this datasheet is completely accurate, and Atmosic hereby disclaims (i) any and all liability for any errors or inaccuracies contained in any datasheet or in any other product literature and any damages or lost profits resulting therefrom; (ii) any and all liability and responsibility for any action you take or fail to take based on the information contained in this datasheet; and (iii) any and all implied warranties which may attach to this datasheet, including warranties of fitness for particular purpose, non-infringement and merchantability. Consequently, you assume all risk in your use of this datasheet, the Atmosic product, and in any action you take or fail to take based upon the information in this datasheet. Any statements in this datasheet in regard to the suitability of an Atmosic product for certain types of applications are based on Atmosic's general knowledge of typical requirements in generic applications and are not binding statements about the suitability of Atmosic products for any particular application. It is your responsibility as the customer to validate that a particular Atmosic product is suitable for use in a particular application. All content in this datasheet is proprietary, copyrighted, and owned or licensed by Atmosic, and any unauthorized use of content or trademarks contained herein is strictly prohibited.

Copyright ©2020-2024 by Atmosic Technologies. All rights reserved. Atmosic logo is a registered trademark of Atmosic Technologies Inc. All other trademarks are the properties of their respective holders. This datasheet is subject to change without notice.