

## Application Note

## ATM32xx Energy Harvesting Application Note

## Revision History

Date	Version	Description
March 6, 2020	0.50	Initial version created.
July 2, 2020	0.51	Updated various sections.
November 23, 2020	0.52	Changed name to ATM32xx, updated various sections.
April 14, 2021	0.53	Updated format, no content change.
July 2, 2021	0.54	Updated <a href="#">PV Harvesting</a> , <a href="#">Thermal Harvesting</a> , <a href="#">Example 1 - PV Harvesting without a Battery</a> and <a href="#">Example 3 - RF Harvesting with a ML2032 Rechargeable Battery</a> sections.

---

## Table of Contents

<b>Overview</b>	4
Related Documentation	4
<b>ATM3 Harvesting and Power Management</b>	4
Cold Start	6
Power Management Scenarios and Battery Options	8
VSTORE Storage Element Considerations	9
<b>ATM3 Harvester Performance</b>	10
RF Harvesting	10
PV Harvesting	13
Thermal Harvesting	16
Mechanical Switch Harvesting	18
<b>Energy Harvesting Programming Examples</b>	20
Example 1 - PV Harvesting without a Battery	20
Example 2 - RF Harvesting with a 3 V non-rechargeable Battery and a 3 V Supercapacitor	22
Example 3 - RF Harvesting with a ML2032 Rechargeable Battery	23

---

## List of Figures

- Figure 1 - Cold Start Latency vs. RF Input Energy Based on Different Cstore Values
- Figure 2 - VBAT and RFIN\_HARV Power Required for Flash Beacon Applications
- Figure 3 - Power at RF Harvester Input
- Figure 4 - Charging Power from RFIN\_HARV to the rechargeable battery
- Figure 5 - I-V and P-V Characteristics of Panasonic Cell AM-1454
- Figure 6 - Power Required for Flash Beacon Applications
- Figure 7 - Charging Power from HARV\_OUT to the rechargeable battery
- Figure 8 - Thermal Harvesting System Block Diagram
- Figure 9 - Thermal harvesting system Hardware Connection
- Figure 10 - Example Application Efficiency Chart, source: MATRIX Mercury Datasheet
- Figure 11 - Mechanical Switch Harvesting System Block Diagram
- Figure 12 - Pressing the ZF Harvesting Switch
- Figure 13 - Examples/BLE\_adv/makefile for Example 1
- Figure 14 - Examples/OTP\_beacon/makefile for Example 2
- Figure 15 - Examples/BLE\_adv/makefile for Example 3

## List of Tables

- Table 1 - Cold Start Requirement and Latency for Batteryless Harvesting Applications
- Table 2 - Power Management Scenarios and Thresholds
- Table 3 - Bill of Materials

---

## Overview

The Atmosic ATM3 series system-on-a-chip (SoC) supports energy harvesting from RF sources or from other modalities such as photovoltaic (PV), thermal (TEG), and mechanical actuation. Harvesting can be employed in completely batteryless configurations or used with a battery (regular or rechargeable) to extend its lifetime. This document describes the functionality of the ATM3 harvester and its performance with RF, PV, thermal or mechanical switch energy sources. This document also includes programming examples to demonstrate how to enable harvesting settings using the ATM3 Software Development Kit (SDK). Please refer to SDK documentation for additional information on building and programming OTP and flash applications.

This document applies to ATM32xx Evaluation Board (EVB) revision D2x. For documentation covering other versions of the EVB, please contact the Atmosic support team. For information on EVB revision and descriptions, please refer to EVK User's Guide for ATMx201/ATMx202.

## Related Documentation

- EVK User's Guide for ATMx201/ATMx202
- Atmosic ATMx2xx Reference Manual
- ATM32x1 EVK Energy Harvesting Quick Start Guide
- Atmosic SDK Quick Start Guide
- ATM32x1 Harvesting Meter Application Note
- Understanding ATM2/3 Low Power Modes White Paper

## ATM3 Harvesting and Power Management

The ATM3's integrated Power Management Unit (PMU) is responsible for the energy transfer between the sources (harvesters and storage elements) and sinks (Bluetooth LE system and peripherals). It also generates the core and I/O supplies required for the SoC. There is a cold start energy requirement for the PMU to boot. After booting, the energy required to sustain operation depends on power consumption of the application.

Please refer to the Power Management Unit section of the ATMx2xx Reference Manual for information about the supported configurations along with block diagrams showing the various interface points: VBAT, HARV\_OUT, HARV1(RFIN\_HARV on EVB) and VSTORE.

The ATM3 initially draws energy from RFIN\_HARV (for RF harvesting) or HARV\_OUT (for non-RF harvesting). Excess energy is transferred to the storage element connected to the VSTORE pin. The storage element can be a regular capacitor, supercapacitor, or a rechargeable battery (the capacitive storage element connected to VSTORE will be referred to as "Cstore" for the rest of this document). Power can be drawn from VSTORE when harvested energy is not sufficient

---

to meet the SoC load requirement. When the harvested energy stored reaches the upper voltage limit on VSTORE the harvester will shut off to prevent damage to the chip as well as the storage element. In cases where the available energy on RFIN\_HARV/HARV\_OUT and VSTORE is not sufficient the ATM3 will draw from VBAT if available.

When there is not enough energy available from the harvester or storage elements, the system will brownout and enter its lowest power state: SoC Off. The ATM3 will keep harvesting in SoC Off and the system will exit brownout when sufficient harvested energy becomes available. If harvested energy remains too low and the chip draws down VSTORE and VBAT to the undervoltage level the ATM3 will stop taking energy. From this state it will reset and require a full cold start to function again. More details on power management will be discussed later in this document.

In systems with a rechargeable battery, VSTORE is connected to VBAT through a series resistor on the EVB and VSTORE is disabled as an energy source for ATM3. The series resistor limits the charging current from VSTORE to the battery. Based on the battery characteristics, the value of the current-limiting resistor, the filter capacitor on VSTORE, the upper voltage limit and the brownout level thresholds should be chosen accordingly to protect the battery and will be discussed later in this document. When there is excess harvesting energy, it is transferred to the storage element on the VSTORE pin, and then to the rechargeable battery through the current-limiting resistor. When the energy on RFIN\_HARV/HARV\_OUT is not sufficient to sustain the instantaneous load, the PMU will draw energy from the rechargeable battery through the VBAT connection.

## Cold Start

Cold start power is the minimum harvesting power level for batteryless operation to start running the power management unit (PMU). When this power requirement is met, the PMU charges up Cstore to 1.75 V and powers up the rest of the SoC.

[Table 1](#) summarizes the cold start requirements and corresponding latency for batteryless harvesting applications on EVB.

**NOTE:** With a battery in the system the cold start energy is immediately supplied by the battery and the cold start latency is negligible.

	Minimum Energy Level	Start up Latency at Min Energy Level (s)
<b>RF Harvesting Application*</b>	-9.5 dBm @ RFIN_HARV	20
<b>Non-RF Harvesting Application</b>	30 $\mu$ W @ HARV_OUT with V(HARV_OUT) > 1.65 V	25

Table 1 - Cold Start Requirement and Latency for Batteryless Harvesting Applications on EVB

\*RF cold start performance is measured with an input signal at 915 MHz and is sensitive to the RF match on RFIN\_HARV.

Cold start latency is the time from when energy is available at the ATM3 input (RFIN\_HARV/HARV\_OUT) to the start of the first beacon. It can be approximated as the time it takes to charge Cstore to 1.75 V based on the amount of available energy to harvest. [Figure 1](#) shows the measured cold start latencies with various RF input power levels at 915 MHz for various Cstore values.

### Cold Start Latency vs. RF Input Power

For 3 storage element values at VSTORE

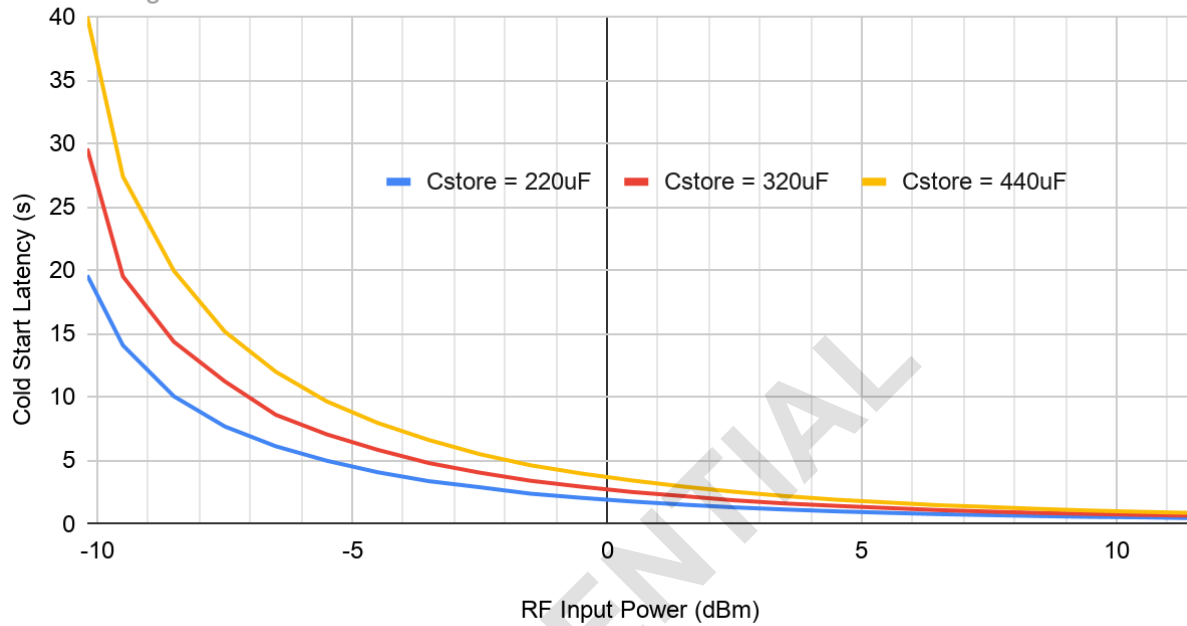

Figure 1 - Cold Start Latency vs. RF Input Power with Different Cstore Values

Higher harvester input energy leads to reduced cold start time. For RF harvesting, increased harvester input energy can be achieved by increasing the power of the RF source transmitter, reducing the distance from the transmitter, optimizing the RFIN\_HARV match, or increasing the antenna gain. For PV harvesting, increased harvester input energy can be achieved by using a more efficient PV cell, a larger PV cell, or a brighter light source.

## Power Management Scenarios and Battery Options

[Table 2](#) below summarizes the power management scenarios and corresponding thresholds, which will be discussed in more detail in the following paragraphs. Please refer to the Power Management Unit section of the ATMx2xx Reference Manual for supported software settings.

Parameter	Description	Value (V)
Upper Voltage Limit	Charging stop voltage on VSTORE, programmed by VSTORE maximum threshold	VSTORE = 3.0 V/3.3 V
System Brownout Level	Systems with regular batteries enters brownout when VBAT is lower than the set thresholds, resumes normal operation when VSTORE > 1.75 V	Configurable
	Batteryless systems enters brownout when VSTORE < 1.6 V, resume normal operation when VSTORE > 1.75 V	VSTORE = 1.6 V (1.75 V)
	Systems with rechargeable batteries enters brownout when VBAT is lower than the set thresholds, resumes normal operation when VBAT cross hysteresis level (set threshold + 200 mV)	Configurable
Undervoltage Limit	Minimum value for battery voltage or VSTORE voltage	VBAT/VSTORE = 0.65 V

Table 2 - Power Management Scenarios and Thresholds

For a system with a regular battery, energy on Cstore can be utilized until VSTORE drops down to 0.65 V, then ATM3 takes power from the battery afterwards. The system will brownout when VBAT voltage is below the set brownout thresholds, and will be brought out of brownout when there is incoming harvesting energy and VSTORE is charged up to 1.75V. In this case the system will behave like a batteryless system described in the next paragraph. When there is not enough incoming harvesting energy, and the energy on VBAT is further utilized to sustain SoC Off mode, VBAT will eventually hit the undervoltage level of 0.65 V and the normal operation stops.

For a batteryless system, energy from VSTORE can be utilized until the voltage drops down to 1.6 V, then the system will brownout. It will be brought out of brownout when VSTORE voltage crosses its hysteresis level, typically at 1.75 V. If it stays too long in SoC Off without incoming harvesting energy and VSTORE is below its under voltage limit of 0.65 V, the ATM3 will reset and require VSTORE to be charged up to 1.75 V again (for cold start) to resume normal operations.



---

For the batteryless scenarios where the user would like to utilize the energy on VSTORE all the way down to the undervoltage level of 0.65 V, it is recommended to disable the system brownout functionality in the software (shown as [Example 1](#) of the [Energy Harvesting Programming Examples](#) section).

For a system with a rechargeable battery, energy on the rechargeable battery will be utilized until VBAT drops down to the set brownout thresholds, and then the system enters brownout. The ATM3 will keep harvesting in brownout and charging the battery when the harvesting power is available. The system will be brought out of brownout when the battery reaches the brownout hysteresis level on VBAT. If harvesting energy remains too low and the VBAT hits the under voltage level, the normal operation stops.

The Maxell ML2032 battery is the default rechargeable battery option supported in this release. The recommended upper voltage limit and brownout level is 3 V and 2.1 V respectively. Please refer to [Example 3](#) of the [Energy Harvesting Programming Examples](#) section for software implementations. The ML2032 has a charge current limit of 2 mA, so a 560  $\Omega$  protection resistor has been added between VBAT and VSTORE on the EVB for battery protection.

## VSTORE Storage Element Considerations

The VSTORE storage element is an energy tank to ensure that constant power is available when needed for the application. It allows the system to handle any peak currents that cannot come directly from the input source.

For batteryless operations, it is recommended to have a capacitor value of at least 220  $\mu\text{F}$  to support the cold start energy requirement. Beyond the minimum Cstore value, there are two considerations in the selection of Cstore: cold start latency and power profile requirements.

For example, in a batteryless operation using the 1 second beacon application with RF harvesting and Cstore = 220  $\mu\text{F}$  (system brownout disabled):

- Cold start latency: as shown in [Figure 1](#), it would take 5 seconds to cold start with -5 dBm.
- Power profile of the load: a 220  $\mu\text{F}$  capacitor charged to full (VSTORE = 3.3 V) can sustain an instantaneous energy withdrawal of 1.15 mJ before system shutdown (VSTORE = 0.65 V). Knowing that the 1 second beacon application consumes an average of 25  $\mu\text{W}$  with battery and no harvesting energy, 1.15 mJ can sustain the application after RF energy is unavailable during gaps for up to 46 seconds.

A larger value of Cstore can sustain a larger power profile of the load with intermittent energy source, but requires a longer cold start. It depends on the user application to select the optimal capacitor value.

---

In the case of a rechargeable battery in the system, the VSTORE storage element would be the battery, and a filter capacitor should be added. It is recommended to have a 220  $\mu\text{F}$  capacitor at VSTORE to create filter with a time constant of roughly 100ms on the charging circuit (ie. 220  $\mu\text{F}$  and 560  $\Omega$  on VSTORE on EVB).

## ATM3 Harvester Performance

This section details the performance of the ATM3 for each of the four supported energy harvesting modes.

### RF Harvesting

Please refer to ATM32xx/ATM22xx Reference Manual for the PMU block diagram (Figure 2.3-2 to Figure 2.3-13) and harvesting type (a) section.

**NOTE:** The RF input port (RFIN\_HARV) has a maximum rating of 9 dBm. Exposing to a higher input RF power can potentially degrade the chip performance and damage the chip.

[Figure 2](#) shows the typical power consumptions from VBAT and RFIN\_HARV for the flash beacon application with various beacon intervals. For demonstration purposes, retention mode is used as a low power mode between beacons. It takes 100  $\mu\text{W}$  (-10 dBm) at RFIN\_HARV port to sustain the 1 second beacon application in steady state. The cold start requirement of -9.5 dBm can sustain a flash beacon application with 0.8 second interval.

VBAT and RFIN\_HARV Power Required to Sustain Beacon Application with Various Intervals

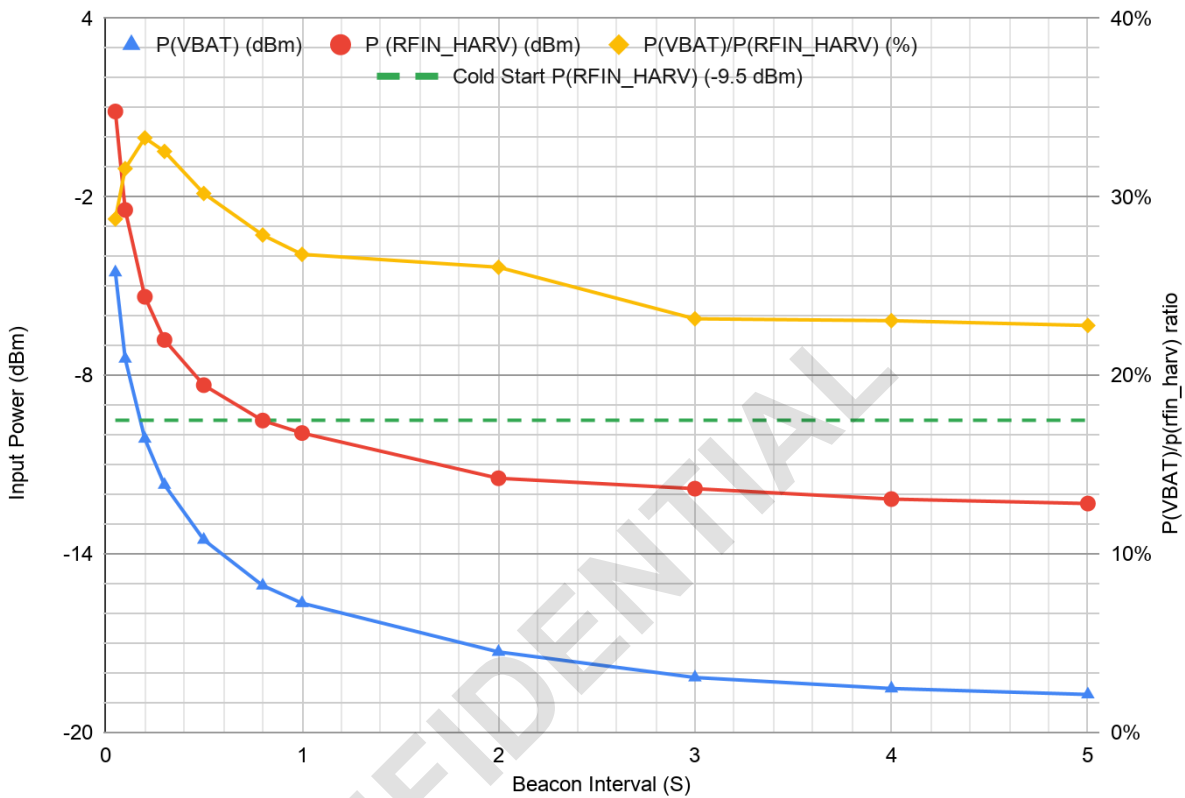

Figure 2 - VBAT and RFIN\_HARV Power Required for Flash Beacon Applications

The power consumption can be further reduced with a longer beacon interval and with a lower power mode between beacons. Please refer to Understanding ATM2/3 Low Power Modes White Paper for more information on low power mode options.

As part of the system design, a RF harvesting source should be considered carefully to support the application load. The received power at the antenna can be estimated by the free-space path loss, as demonstrated in [Figure 3](#). From a 36 dBm (4 Watt) source, the diagram below shows the calculated received power versus distance for both 915 MHz and 2.4 GHz frequencies.

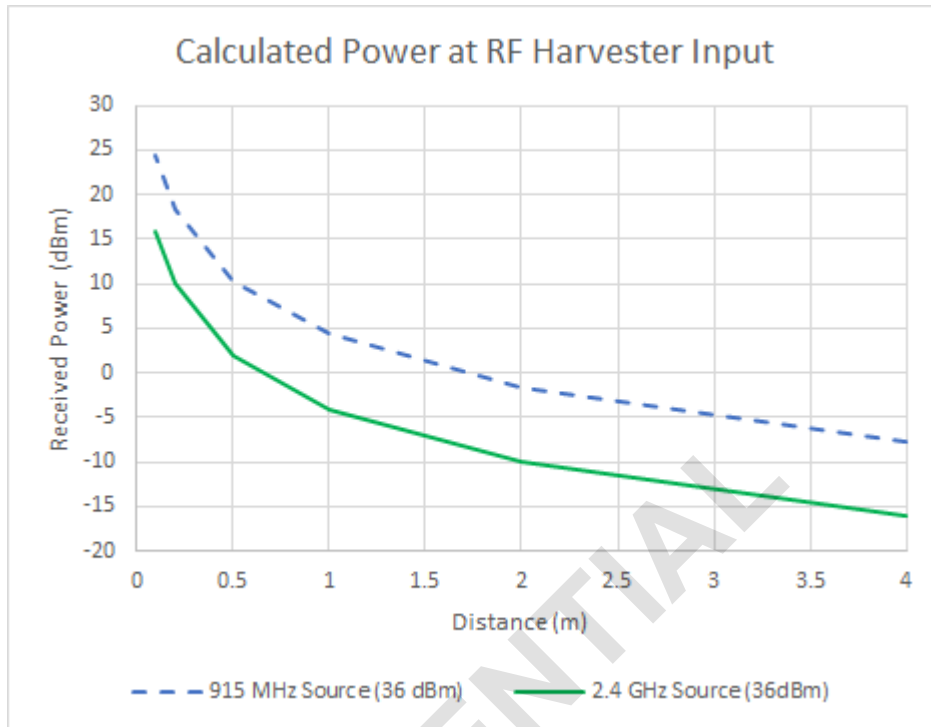

Figure 3 - Power at RF Harvester Input

For the actual harvested power measured at VSTORE, the EVB can be repurposed as a characterization tool of a harvesting meter. Please refer to the ATM32x1 Harvesting Meter Application Note for more information.

For systems with rechargeable batteries, the charging power delivered to the battery is characterized on EVB. [Figure 4](#) shows the charging power to the battery at various RFIN\_HARV input power levels at 915 MHz. The RF harvester design has a multi-stage rectifier so there are discontinuities in the curve when the rectifier is switching between stages as the RF power changes.

The data is taken at the middle of the battery voltage range (2.4 V) and the power consumption on the current-limiting resistor (560 Ω) has been taken into account. Please note that the charging power will deviate from the curve below when harvesting with VBAT and VSTORE close to the upper voltage limit and the charging current will be limited by the harvester upper voltage control.

RF Harvesting (at 915MHz): Rechargeable Battery Charging Power and Efficiency with ML2032, VBAT = 2.4V

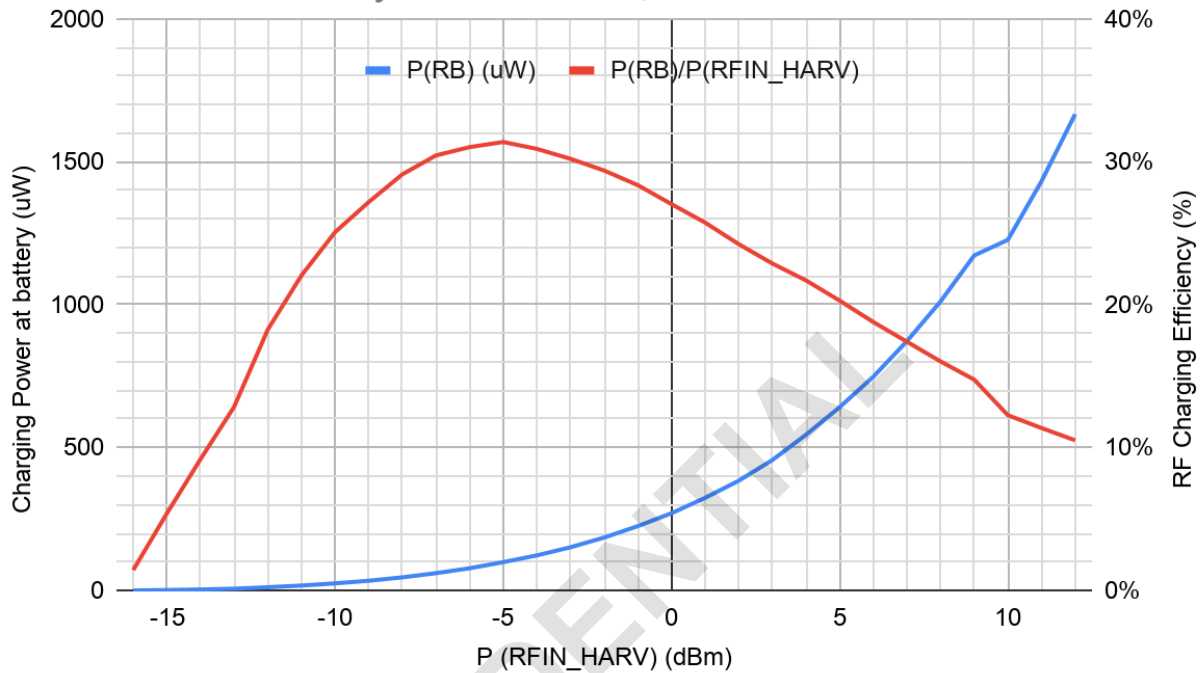

Figure 4 - Charging Power from RFIN\_HARV to the rechargeable battery

## PV Harvesting

Please refer to ATMx2xx Reference Manual for the PMU block diagrams (Figure 2.3-2 to Figure 2.3-13) and harvesting type (b) section.

To fulfill the cold start voltage requirement at HARV\_OUT for a batteryless operation, the selected PV cell should provide at least 30  $\mu$ W above 1.65 V at the illumination level of the targeted application. If a battery is in the system, the PV cell does not have this limit, and only the operating voltage (described below) is of interest.

The PV cell operating voltage can be regulated by HARV\_OUT after the cold start, and the voltage range can be programmed to one of the six settings between 1.1 - 1.9 V (see section [Energy Harvesting Programming Examples](#) for software implementations). Ideal performance is achieved when using a PV cell that operates within the available programmable range. The ATM3 cannot be used with a PV cell with an operating voltage lower than 1.1 V, and the ATM3 will not be able to utilize all the available energy from a PV cell with an operating voltage higher than 1.9 V.

**NOTE:** the non-RF input port (HARV\_OUT) has a maximum rating of 9mW at 3.3 V. Exposing the PV cell to any possible illumination level that might reach the maximum rating can potentially degrade the chip performance and damage the chip.

For the Panasonic PV cell included in the ATM32x1 Evaluation Kit ([datasheet](#)), at indoor office illumination levels (approximately 200 to 1000 lux), the highest power can be extracted at around 2 V ([Figure 5](#)). The highest voltage regulation range of 1.6 V-1.9 V should be selected in the software, offering close to optimum power transfer from the PV cell as the loss is less than 5%.

AM-1454 I-V measurements for Various Lighting Levels

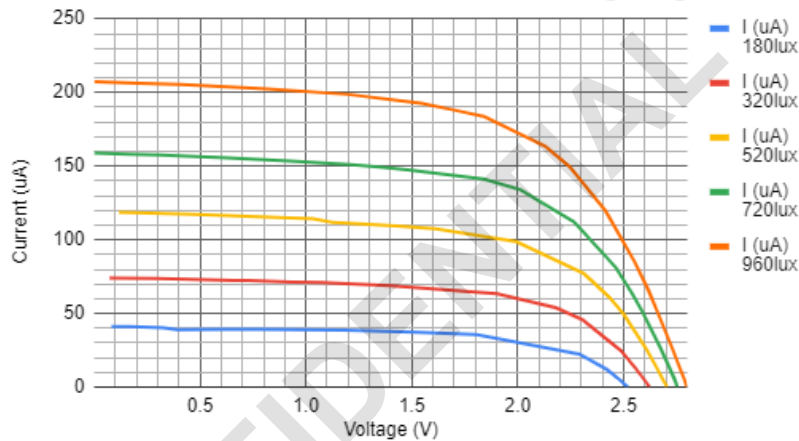

AM-1454 P-V measurements over Various Lighting Levels

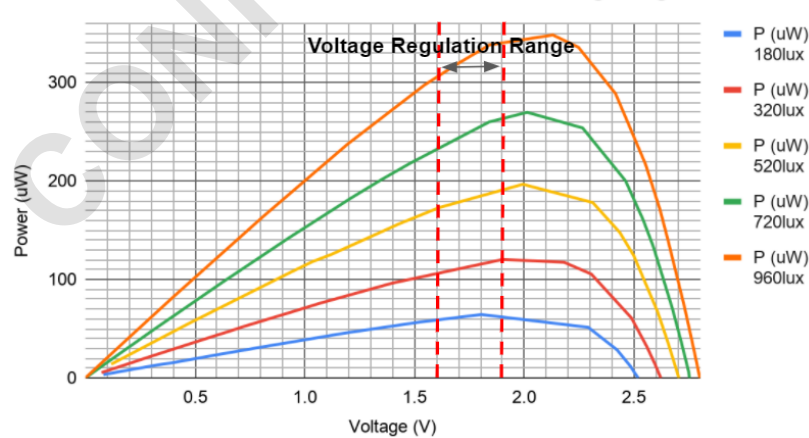

Figure 5 - I-V and P-V Characteristics of Panasonic Cell AM-1454

[Figure 6](#) shows the typical power consumptions from VBAT and HARV\_OUT for the flash beacon application with various beacon intervals. For demonstration purposes, retention mode is used as sleep state during beacons. Please refer to Understanding ATM2/3 Low Power Modes White Paper for detailed information and more options.

The cold start requirement of 30  $\mu\text{W}$  at HARV\_OUT can sustain a flash beacon application with approximately 1 second interval. Due to the energy loss when storing energy to and drawing energy from VSTORE, a PV harvested beacon application consumes up to 25 % more power compared to the same application powered by battery. The exact required harvesting power depends on how much energy is taken from HARV\_OUT or VSTORE. Higher efficiency can be observed on beacon applications with longer intervals.

### VBAT and HARV\_OUT Power Required to Sustain Beacon Application with Various Intervals

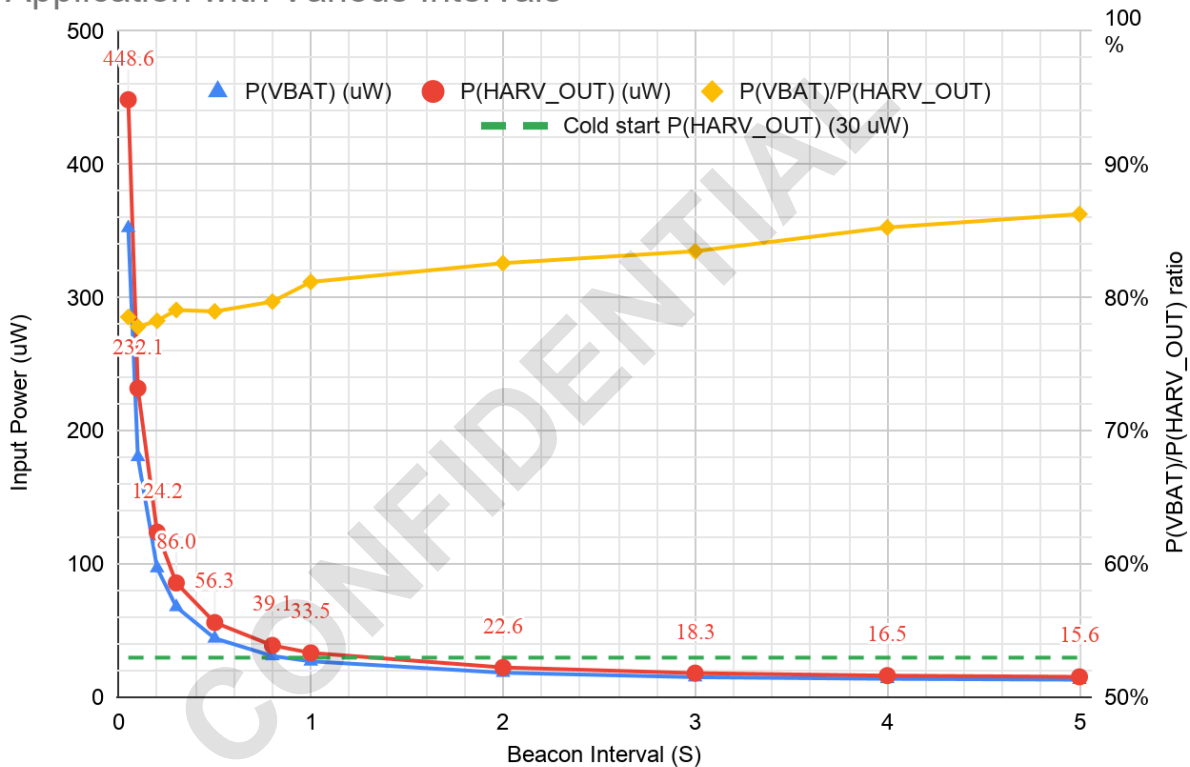

Figure 6 - VBAT and HARV\_OUT Power Required for Flash Beacon Applications

For systems with rechargeable batteries, the charging power delivered to the battery has been characterized on the EVB. [Figure 7](#) shows the charging power delivered to the battery from the HARV\_OUT input power for non-RF harvesting implementations. The charging efficiency from HARV\_OUT to VSTORE is approximately 70 % across the input power levels. The charging efficiency from HARV\_OUT to the rechargeable battery drops below 70% at high input power levels due to increased loss across the protection resistor (560  $\Omega$ ).

This data was taken at the middle (2.4 V) of the battery voltage range. Please note that the charging power will deviate from the curve below when harvesting with VBAT and VSTORE close to the upper voltage limit and the charging current will be limited by the harvester upper voltage control.

Non-RF Harvesting: Rechargeable Battery Charging Power and Efficiencies with ML2032, VBAT = 2.4V

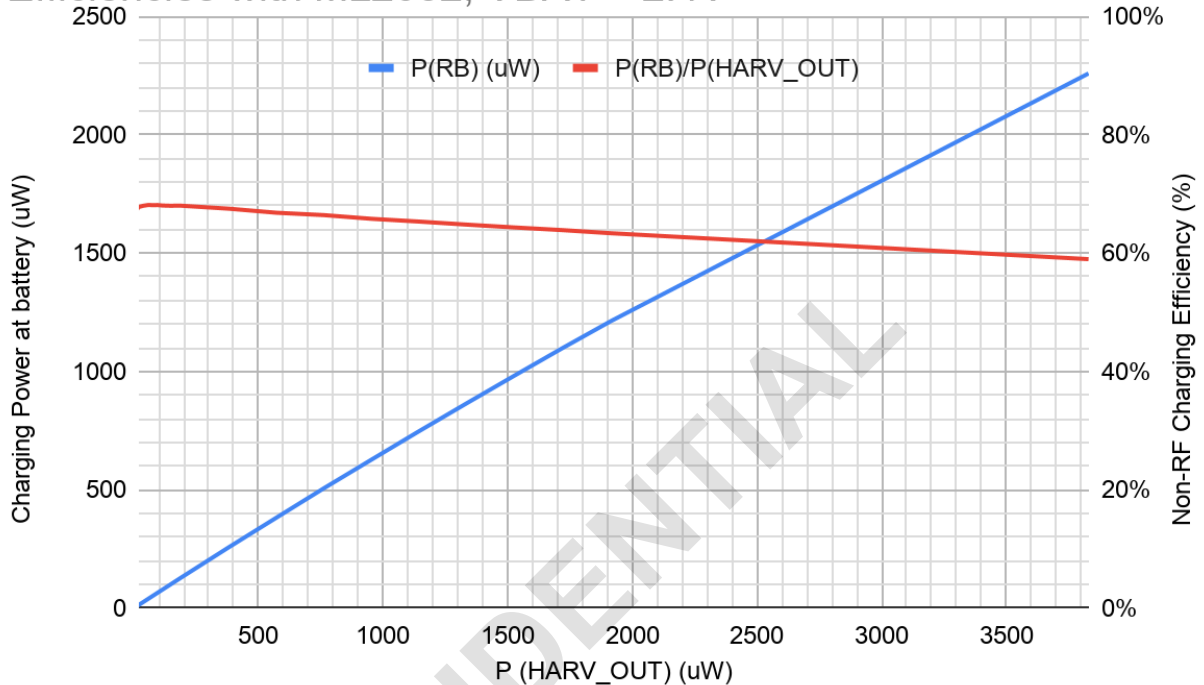

Figure 7 - Charging Power from HARV\_OUT to the rechargeable battery

## Thermal Harvesting

Please refer to ATM32xx/ATM22xx Reference Manual Figure 2.3-6 for the PMU block diagram and harvesting type (b) section that support thermal harvesting.

Atmosic has partnered with MATRIX Industries to combine the ATM3 with MATRIX’s Mercury boost converter to provide a complete thermal energy harvesting solution with the MATRIX Gemini TEG.

Related documents from MATRIX [www.matrixindustries.com](http://www.matrixindustries.com):

- MATRIX Mercury datasheet
- Mercury Boost Converter Evaluation Kit datasheet

[Figure 8](#) and [Figure 9](#) show a system solution that uses the thermal energy generated by a thumb press to run the 1 second beacon application. The highest voltage range setting 1.6 V-1.9 V should be selected for voltage regulation at HARV\_OUT.



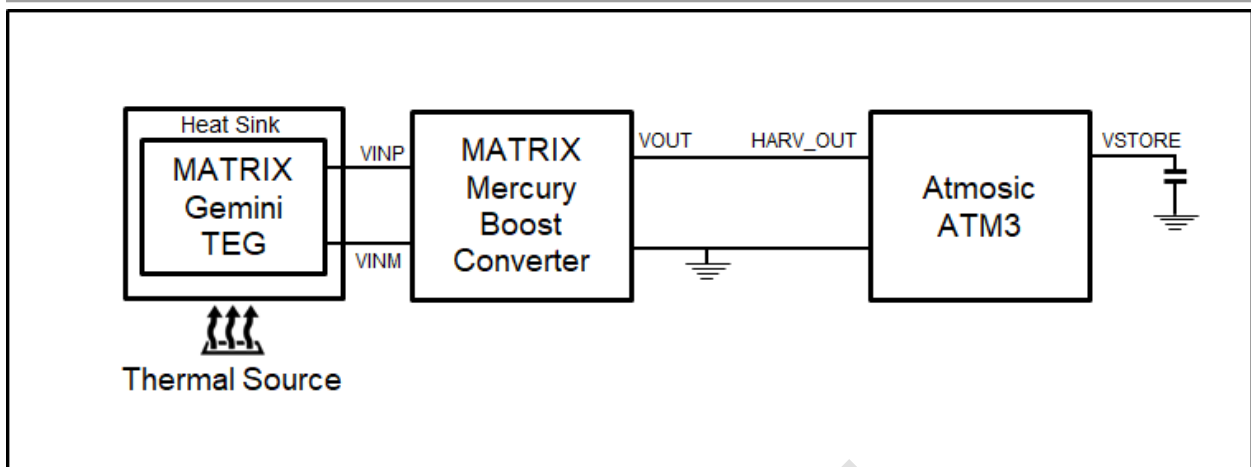

Figure 8 - Thermal Harvesting System Block Diagram

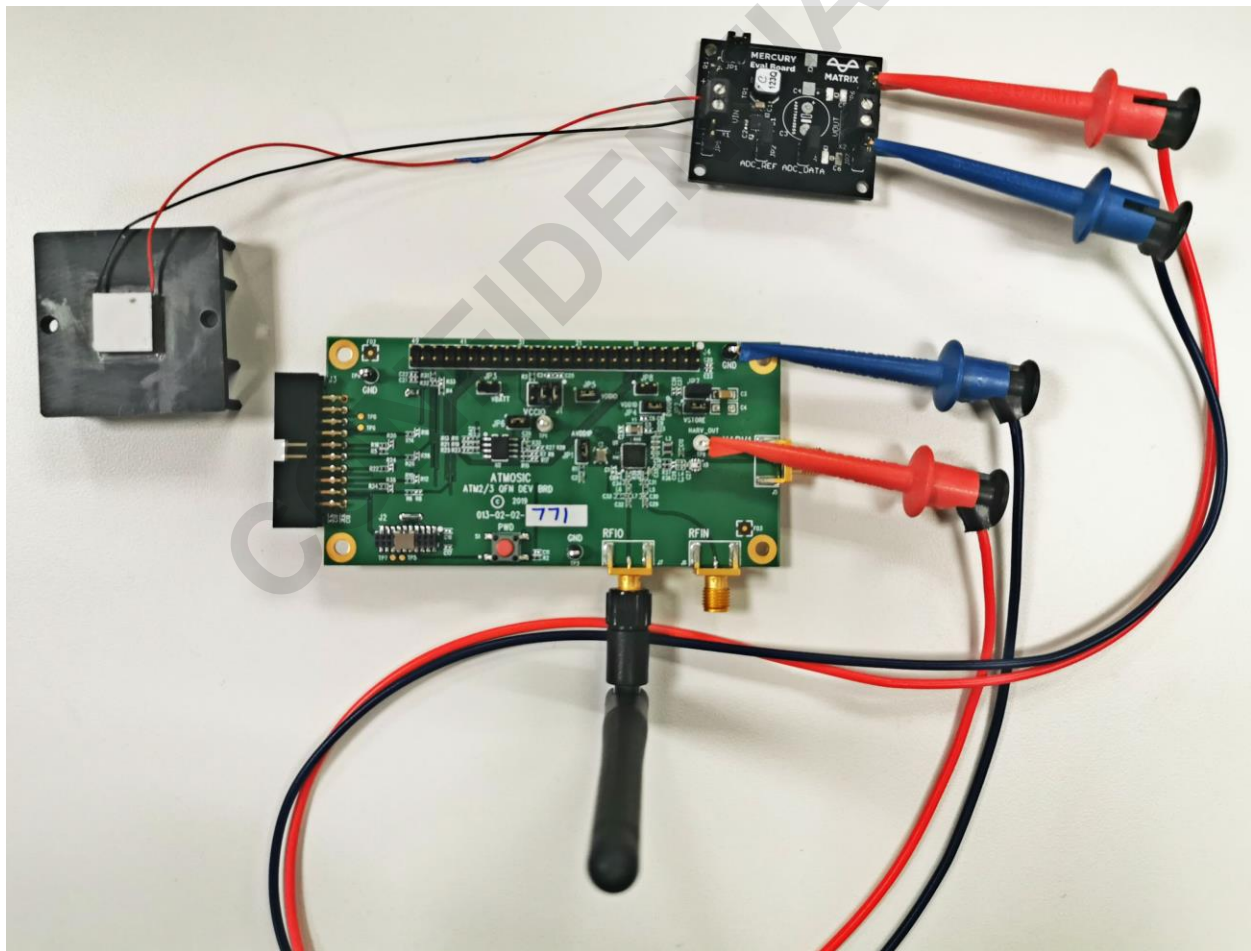

Figure 9 - Thermal harvesting system Hardware Connection

The Mercury boost converter is optimized for 12 Ω input impedance, 12.5 μH inductor (LPR6235) and 3.0 V output. This is a nonstandard version, please contact MATRIX [info@matrixindustries.com](mailto:info@matrixindustries.com) to request samples.

To identify the specific TEG solutions for application of interest, Atmosic recommends working directly with MATRIX. There are three primary considerations to discuss with Matrix: open circuit input voltage of the MATRIX Mercury boost circuit (Voc), the thermal heat source available and TEG area.

[Equation 1](#) and the MATRIX Mercury efficiency curve ([Figure 10](#)) can be used to calculate Voc. If the application requires 45 μW at HARV\_OUT, Voc is found to be 60 mV.

The example application uses a thumb press directly on the TEG to transmit beacons, so the energy source and area is constrained by the thumb. With the TEG proposed by Matrix (0.5 inch x 0.5 inch), body heat at the thumb of an average person can generate Voc of 60 mV to 120 mV, which corresponds to 45 μW to 220 μW at HARV\_OUT, sufficient for beacon applications.

$$\text{Efficiency} = \frac{P_{out}}{P_{max}} = \frac{P_{out} \times 4 R_{TEG}}{V_{oc}^2} = \frac{45 \mu W \times 4 \times 12 \Omega}{V_{oc}^2} \quad (1)$$

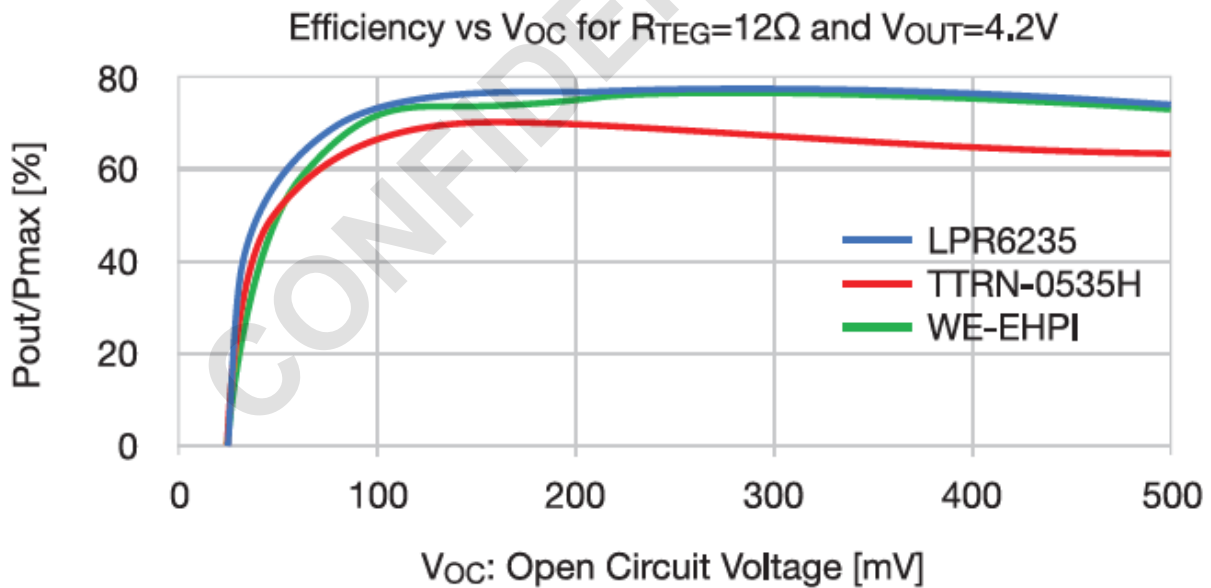

Figure 10 - Example Application Efficiency Chart, source: MATRIX Mercury Datasheet

Knowing that the ATM3 requires 30 μW at HARV\_OUT pin to cold start, Voc of the MATRIX Mercury has to be at least 56 mV to start up the ATM3.

## Mechanical Switch Harvesting

The software application to support mechanical switch harvesting is available as an Atmosic SDK example: mech\_switch\_harv. The sample application is OTP based and transmits four sets

of beacons at a 50 ms interval. Please follow the instructions in the README file in the example folder to build the application. To further optimize PMU for harvested energy, “NO\_VBAT” setting can be applied in software. However once the batteryless setting is applied, the ATM3 cannot be reprogrammed or debugged through the interface board.

[Figure 11](#) shows the schematics of a mechanical switch harvesting system with the ATM3. [Table 3](#) lists the bill of materials for components not included in the ATM32x1 EVB.

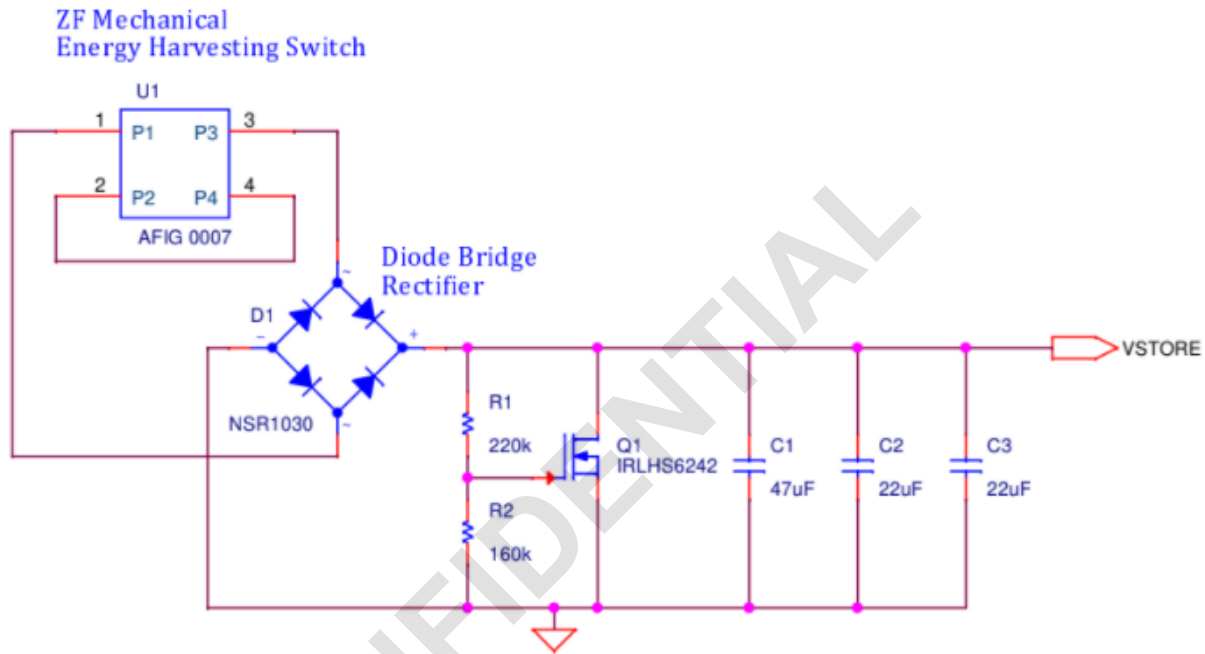

Figure 11 - Mechanical Switch Harvesting System Block Diagram

Item	MFG Part #	MFG	Description
U1	AFIG-0007	ZF Electronics	Mechanical Switch as energy harvesting generator
D1	NSR1030QMUTWG	ON Semiconductor	Bridge Rectifier Single Phase Schottky 30 V Surface Mount 4-UDFN (3x3)
Q1	IRLHS6242TRPBF	Infineon Technologies	Discrete Power MOSFET 40 V Surface Mount 6-PQFN (2x2)

Table 3 - Bill of Materials

The mechanical energy generator AFIG-0007 from ZF electronics ([Figure 12](#)) can harvest 0.3 mJ of energy from a single press or release. 0.2 mJ of this energy is captured on the 91 μF Cstore capacitor which is sufficient for the ATM3 to cold start and transmit a total of 9 beacons. There is an additional 10 μF required to be placed close to the VSTORE pin, which is available on EVB and not captured in [Figure 11](#).

**NOTE:** For optimal energy harvesting, please do not cover the white cap of the AFIG-0007 when operating the switch.

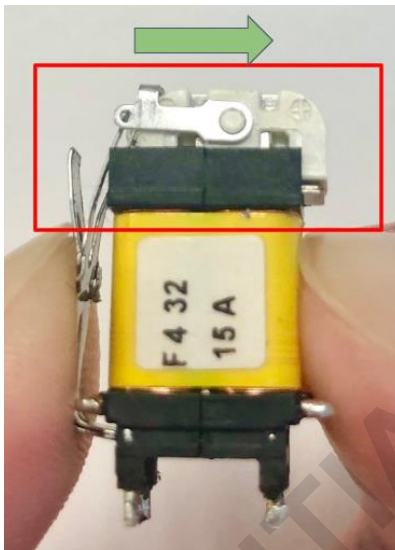

Figure 12 - Pressing the ZF Harvesting Switch

## Energy Harvesting Programming Examples

Energy harvesting software settings can be applied to the SDK example applications by indicating the battery options and harvesting mechanism in the application's makefile. For all the energy harvesting settings supported by the SDK, please refer to ATMx2xx Reference Manual Power Management Unit section.

Three programming examples are included below to demonstrate how to modify the makefile to enable harvesting settings. The "simple\_harv\_beacon" example application is used, which transmits scannable beacons every second and enters a low power mode between advertisements (referred to as "1 second beacon application" in later sections.) For instructions on how to install the SDK and program the EVB, please refer to SDK Quick Start Guide.

### Example 1 - PV Harvesting without a Battery

In this example, the 1 second beacon application is programmed in flash. The makefile flags enable PV harvesting energy (Figure 13 blue) without a battery (Figure 13 green) in the system. VSTORE is set to regulate at 3.3V as it is the maximum allowed level (Figure 13 white). The PV cell is configured for a desired operating voltage from 1.6 V to 1.9 V (Figure 13 red). The user can disable the system brownout functionality as shown in orange.

**NOTE:** Once the batteryless setting (Figure 14 green) is applied, VBAT access will be disabled. Depending on versions of the EVB and the interface board, the ATM3 cannot be reprogrammed or debugged through the interface board. Users can connect VBAT and VSTORE together to regain access.

## Steps:

1. In the SDK examples “BLE\_adv” folder, modify the makefile as shown in [Figure 13](#).
2. Run “make clean”
3. Run “make REF\_BCN:=simple\_harv\_beacon run\_all” to build the application and load it to the target. **Note:** For no battery setting, it is recommended to disable DEBUG to save energy for cold start.

```
1 include ../../../../common/user/common.mk
2
3 ifndef RUN_IN_RAM
4 DEBUG := 1
5 endif
6
7 PMU_CFG := NO_VBAT
8 NO_BROWNOUT := 1
9 CFLAGS += -DCFG_NONRF_HARV -DCFG_NONRF_VRANGE_1p6_1p9 -DVSTORE_MAX_EQ_3p3V
10
11 DRIVERS := interrupt timer sw_timer atm_ble atm_pm
12 LIBRARIES := prf
13
14 FRAMEWORK_MODULES := \
15     atm_adv \
16     atm_asm \
17     atm_common \
18     atm_debug \
19     atm_gap \
20     atm_log \
21     ble_gap \
22
23 UU_TEST := atm_adv
24 INCLUDES += .
25
26 CFLAGS += \
27     -DNO_GAP_SEC \
28     -DNO_ATM_SCAN \
29     -DNO_BLE_GATTC \
30     -DGAP_ADV_PARAM_NAME="config_adv_params.h" \
31
32 ifdef CFG_DYN_ADV
33 CFLAGS += \
34     -DCFG_DYN_ADV \
35     -DCFG_ADV_CREATE_PARAM_CONST=0 \
36     -DCFG_ADV_DATA_PARAM_CONST=0
37 endif
38
39 include reference_beacons.mk
40
```

Figure 13 - Examples/BLE\_adv/makefile for Example 1

## Example 2 - RF Harvesting with a 3 V non-rechargeable Battery and a 3 V Supercapacitor

In this example, the 1 second beacon application is programmed in OTP. The makefile flags enable RF harvesting (Figure 14 blue) with a 3V battery (Figure 14 green) in the system. VSTORE is set to regulate at 3 V to align with the supercapacitor voltage rating (Figure 14 white). There is no system brownout support for OTP applications, therefore it is unnecessary to program a system brownout threshold.

Steps:

1. In the SDK examples “OTP\_beacon” folder, modify the makefile as shown in Figure 14.
2. Run “make clean”
3. Run “make REF\_BCN:=simple\_harv\_beacon run\_all” to build the application and load it to the target.

```
1
2 include ../../../../common/user/common.mk
3
4 include reference_beacons.mk
5
6 PMU_CFG := VBAT_GT_1p8V_VDDIO_INT
7 CFLAGS += -DCFG_RF_HARV -DVSTORE_MAX_EQ_3p0V
8
9 power_cut_kqs := \
10 fd-MEM_W/cut_ksmqdec \
11 fd-MEM_W/cut_shub \
12 fd-MEM_W/rif_reset_fix_1 \
13 fd-MEM_W/rif_reset_fix_2 \
14
15 power_cut_kqsw := \
16 $(power_cut_kqs) \
17 fd-MEM_W/cut_wurx \
18
19 reference_beacon_power_profile += $(power_cut_kqsw)
20 reference_beacon_extended_adv += $(power_cut_kqsw)
21 reference_beacon_extended_con += $(power_cut_kqsw)
22 reference_beacon_extended_scn += $(power_cut_kqsw)
23 reference_beacon_2M_secondary += $(power_cut_kqsw)
24 reference_beacon_LR_coded += $(power_cut_kqsw)
25 reference_beacon_LR500_coded += $(power_cut_kqsw)
26 reference_beacon_iBeacon += $(power_cut_kqsw)
27 reference_beacon_WURX += $(power_cut_kqs)
28
29 otp_nvds.data := $(reference_beacon_$(REF_BCN))
30
31 include $(COMMON_USER_DIR)/nvds.mk
"examples/OTP_beacon/makefile" 31L, 878C 7,1 All
```

Figure 14 - Examples/OTP\_beacon/makefile for Example 2

---

## Example 3 - RF Harvesting with a ML2032 Rechargeable Battery

In this example the 1 second beacon application is programmed in flash. The makefile flags shown in [Figure 15](#) enable RF harvesting energy (highlighted in [blue](#)) and a 3 V rechargeable battery (highlighted in [orange](#)). Based on the battery characteristics of ML2032, the upper voltage limit is set at 3 V (highlighted in [red](#)), and the brownout threshold is set at 2.1 V (highlighted in [yellow](#)).

The software settings assume an internal IO configuration. To program for external IO configuration, please uncomment the line in [green](#).

Steps:

1. In the SDK examples “BLE\_adv” folder, modify the makefile as shown in [Figure 15](#).
2. Run “make clean”
3. Run “make REF\_BCN:=simple\_harv\_beacon run\_all” to build the application and load it to the target.

CONFIDENTIAL

```
1 include ../../../../common/user/common.mk
2
3 ifndef RUN_IN_RAM
4 DEBUG := 1
5 endif
6
7 # uncomment the following line for external IO
8 # PMU_CFG := VBAT_GT_1p8V_VDDIO_EXT
9
10
11 CFLAGS += -DCFG_RF_HARV
12
13 CFLAGS += -DCFG_RECHBATT -DVSTORE_MAX_EQ_3p0V -DBRWNOUT_THR=4
14
15 DRIVERS := interrupt timer sw_timer atm_ble atm_pm
16 LIBRARIES := prf
17
18 FRAMEWORK_MODULES := \
19     atm_adv \
20     atm_asm \
21     atm_common \
22     atm_debug \
23     atm_gap \
24     atm_log \
25     ble_gap \
26
27 UU_TEST := atm_adv
28 INCLUDES += .
29
30 CFLAGS += \
31     -DNO_GAP_SEC \
32     -DNO_ATM_SCAN \
33     -DNO_BLE_GATTC \
34     -DGAP_ADV_PARM_NAME="config_adv_params.h" \
35
36 ifdef CFG_DYN_ADV
37 CFLAGS += \
38     -DCFG_DYN_ADV \
39     -DCFG_ADV_CREATE_PARAM_CONST=0 \
40     -DCFG_ADV_DATA_PARAM_CONST=0
41 endif
42
43 include reference_beacons.mk
44
```

Figure 15 - Examples/BLE\_adv/makefile for Example 3





## ATMOSIC TECHNOLOGIES - DISCLAIMER

This product document is intended to be a general informational aid and not a substitute for any literature or labeling accompanying your purchase of the Atmosic product. Atmosic reserves the right to amend its product literature at any time without notice and for any reason, including to improve product design or function. While Atmosic strives to make its documents accurate and current, Atmosic makes no warranty or representation that the information contained in this document is completely accurate, and Atmosic hereby disclaims (i) any and all liability for any errors or inaccuracies contained in any document or in any other product literature and any damages or lost profits resulting therefrom; (ii) any and all liability and responsibility for any action you take or fail to take based on the information contained in this document; and (iii) any and all implied warranties which may attach to this document, including warranties of fitness for particular purpose, non-infringement and merchantability. Consequently, you assume all risk in your use of this document, the Atmosic product, and in any action you take or fail to take based upon the information in this document. Any statements in this document in regard to the suitability of an Atmosic product for certain types of applications are based on Atmosic's general knowledge of typical requirements in generic applications and are not binding statements about the suitability of Atmosic products for any particular application. It is your responsibility as the customer to validate that a particular Atmosic product is suitable for use in a particular application. All content in this document is proprietary, copyrighted, and owned or licensed by Atmosic, and any unauthorized use of content or trademarks contained herein is strictly prohibited.

Copyright ©2020-2021 by Atmosic Technologies. All rights reserved.

[www.atmosic.com](http://www.atmosic.com)