

ATM33e/ATM34e Series Energy Harvesting EVK

User Guide

SUMMARY: This guide explains how to connect a PV cell or RF source to power up the ATM33e and ATM34e Wireless SoC Series Evaluation Board (EVB), and evaluate the harvesting performance.



Atmosic™

CONFIDENTIAL | ATM33e/ATM34e Series Energy Harvesting
EVK User Guide
July 19, 2024
4249-0083-0066

Table of Contents

User Guide	1
Table of Contents	2
List of Figures	3
List of Tables	3
Acronyms and Abbreviations	5
1. Overview	6
2. Hardware and Software Requirements	6
2.1 Supported EVK	6
2.1.1 Additional Hardware	7
2.3 Supported SDK	7
3. EVK Setup	7
3.1 Connecting to the EVB	8
3.2 DIP Switches	12
3.3 External Charging Booster Configurations on EVK	15
3.4 Power Cycling the EVB	18
4. Setup with RF Sources	18
4.1 RF Source Transmitter Board	18
5. Setup with PV Source	21
Reference Documents	23
Revision History	24

List of Figures

Figure 1 - Items included in the ATM3330e Evaluation Kit (EVK)

Figure 2 - Features Needed to Operate the ATM3330e EVB version 3 (ATMEVK-3330e-QN-6)

Figure 3 - Features Needed to Operate the ATM3330e EVB version 4 (ATMEVK-3330e-QN-7) and the ATM3430e EVB version 1 (ATMEVK-3430e-WQN-2)

Figure 4 - EVB Power Measurement Jumpers Configuration - J-Link Bypass, for ATM3330e EVB version 3 (ATMEVK-3330e-QN-6)

Figure 5 - EVB Power Measurement Jumpers Configuration - J-Link Bypass, for ATM3330e EVB version 4 (ATMEVK-3330e-QN-7) and the ATM3430e EVB version 1 (ATMEVK-3430e-WQN-2)

Figure 6 - DIP Switches Marking for ATM3330e/ATM3430e

Figure 7 - Operation of ATM3330e EVB version 4 (ATMEVK-3330e-QN-7) and ATM3430e EVB version 1 (ATMEVK-3430e-WQN-2) External Charging Booster - Main Components

Figure 8 - Antenna Connection

Figure 9 - EVB (Left) Setup with RF Source Transmitter (Right)

Figure 10 - EVB Detected by ViewTool Hollong Bluetooth LE Sniffer

Figure 11 - EVB Setup with PV Cell, for ATM3330e EVB version 3 (ATMEVK-3330e-QN-6)

Figure 12 - EVB Setup with PV Cell, for ATM3330e EVB version 4 (ATMEVK-3330e-QN-7) and the ATM3430e EVB version 1 (ATMEVK-3430e-WQN-2)

Figure 13 - EVB Detected by ViewTool Hollong Bluetooth LE Sniffer

List of Tables

Table 1 - Applicable SoC and EVK

Table 2 - RF Source Transmitter Board Ordering Information

Table 3 - Harvesting Modes Selection Summary

Table 4 - Harvesting Mode Selection Details

Table 5 - 3 DIP Switch Settings for Evaluating External Charging Boosting Options

Table 6 - Jumper Configurations for Three External Charging Boosting Options

Acronyms and Abbreviations

Acronyms	Definition
EVB	Evaluation Board
EVK	Evaluation Kit
PMU	Power Management Unit
PV	Photovoltaic
RF	Radio Frequency
SDK	Software Development Kit
SMA	Subminiature version A
SoC	System on Chip
TEG	Thermoelectric Generator

1. Overview

The Atmosic ATM33e/ATM34e Wireless SoC series can be powered by harvesting energy from sources such as PV, TEG, RF, or mechanical actuation. Harvesting can be used with a battery (non-rechargeable or rechargeable) to extend its lifetime. The ATM3330e and ATM3430e EVBs are pre-programmed with an application that demonstrates harvesting with the provided coin cell or an optional rechargeable battery.

This guide explains how to connect a PV cell or RF source to power up the ATM3330e/ATM3430e EVB, with a battery in the system and evaluate the harvesting performance. For more information on energy harvesting operation and performance with a non-rechargeable battery, please refer to the **ATM33e/ATM34e Series Energy Harvesting Application Note**. For more information on energy harvesting with a high-voltage battery or rechargeable storage device, please refer to the **ATM33/e ATM34/e Support for External Energy Storage Devices Application Note** (both documents are available on the Atmosic Support website).

For a general description of the EVB, please refer to the **ATM33/e Series Evaluation Kit User Guide** and **ATM34/e Series Evaluation Kit User Guide**.

2. Hardware and Software Requirements

2.1 Supported EVK

EVK	SoC	SoC Part Number	Kit Part Number
Evaluation Kit for ATM3330e, version 3	56-pin 7x7 mm QFN	ATM3330E-5DCAQN	ATMEVK-3330e-QN-6
Evaluation Kit for ATM3330e, version 4	56-pin 7x7 mm QFN	ATM3330E-5DCAQN	ATMEVK-3330e-QN-7
Evaluation Kit for ATM3430e, version 1	56-pin 7x7 mm QFN	ATM3430E-2WCAQN	ATMEVK-3430e-WQN-2

Table 1 - Applicable SoC and EVK

Note: Energy harvesting feature applies to ATM33e/ATM34e Wireless SoC series only.

2.1.1 Additional Hardware

Atmosic provides a 915 MHz RF energy source for RF harvesting evaluation and must be ordered separately. See [Table 2](#) for the ordering information.

	Kit Part Number
RF Source Transmitter Board	ATMRFS-M22xx-02

Table 2 - RF Source Transmitter Board Ordering Information

2.3 Supported SDK

The Atmosic SDK 6.0.0 or later can be used with the EVK. Refer to the SDK User Guide for more information.

3. EVK Setup

ATM3330e/ATM3430e EVB is pre-configured with the **BLE_harv_adv** SDK example. It is an application that transmits scannable beacons every 10 seconds and enters a low-power state between advertisements. The application supports powering the EVB from a standard coin cell battery or an external rechargeable battery. The rechargeable battery can be charged through RF or PV harvesting. In addition, customers have the option to direct the harvested energy to SoC for regular operations, or direct harvested energy to the storage element for measurement and characterization. The EVB on-board DIP switches select these options.

The ATM3330e EVK and the ATM3430e EVK comprise the following components listed below and shown in [Figure 1](#):

- ATM3330e EVB or ATM3430e EVB
- 1x 2.4 GHz whip antenna: GW.15.2113 ([datasheet](#))
- 1x 915 MHz whip antenna: ANT-916-CW-HWR-SMA ([datasheet](#))
- 1x USB-A to micro-B cables
- 1x Panasonic PV cell: AM-1454 ([product info](#))
- 1x CR2032 coin cell battery

ATM3330e/ATM3430e Evaluation Board

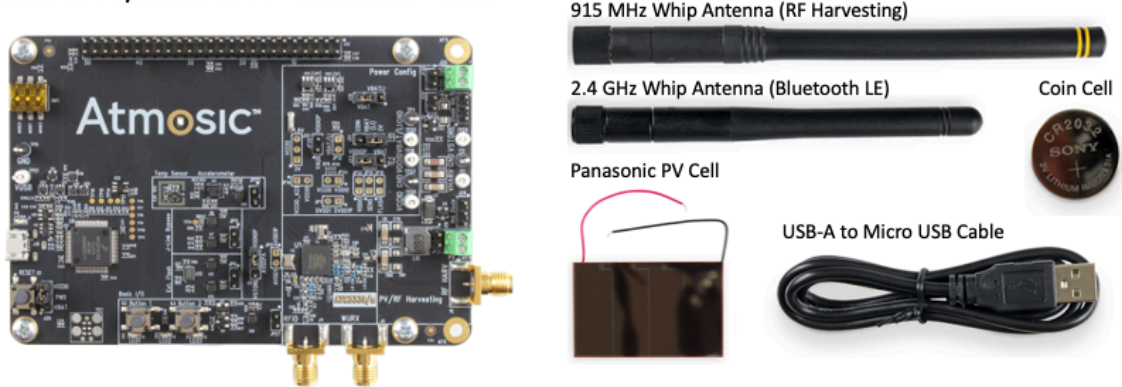
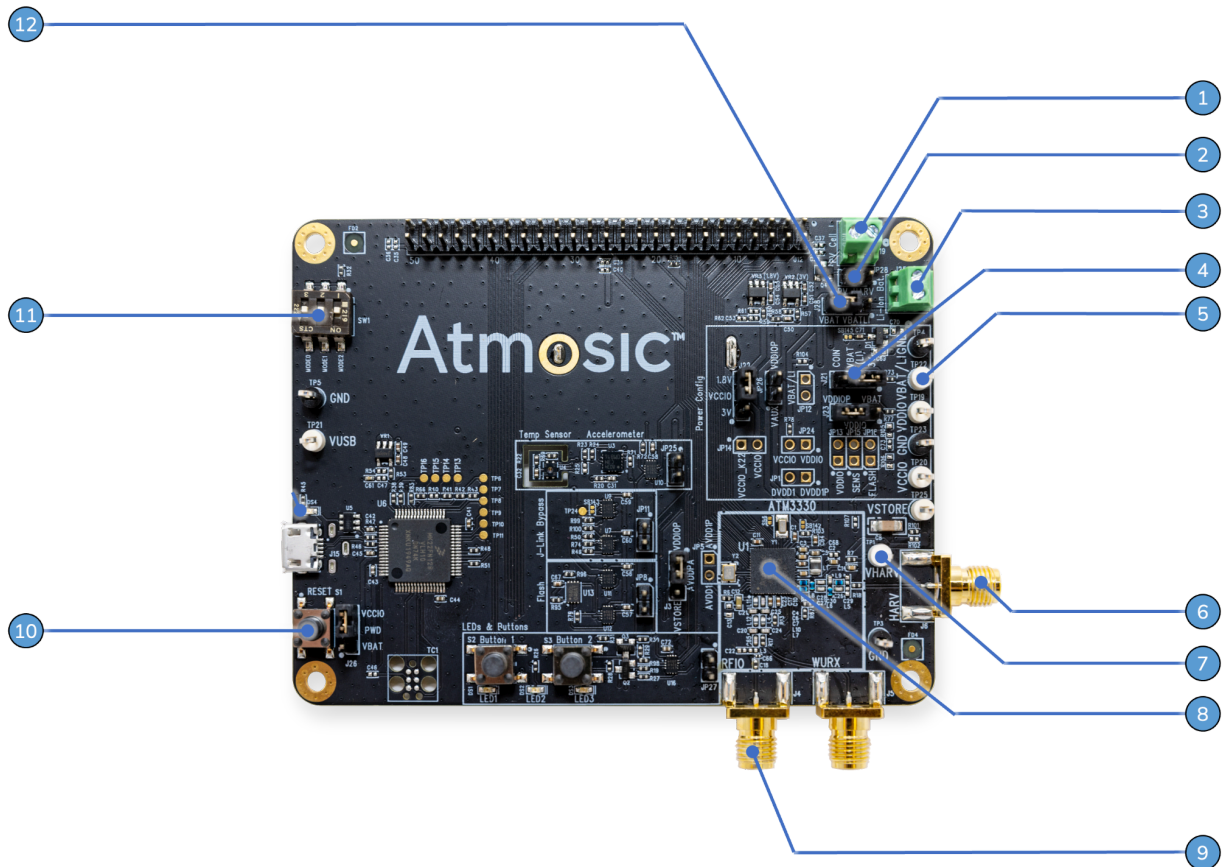

Figure 1 - Items included in the ATM3330e/ATM3430e EVK (ATM3330e version 4 EVK is shown as an example)

3.1 Connecting to the EVB

[Figure 2](#) and [Figure 3](#) show the locations of specific features needed to operate the ATM3330e EVB and the ATM3430e EVB.



- | | |
|---|--------------------------------------|
| 1 - PV Cell Connector (J19) | 7 - VHARV Test Point (TP1) |
| 2 - Concurrent Harv. Enable (JP28) | 8 - ATM3330e |
| 3 - Li-Ion Battery Connector (J25) | 9 - Bluetooth LE RFIO Connector (J4) |
| 4 - VBAT(LI) Source Select Jumper (J21) | 10 - Reset Button (S1) |
| 5 - VBAT(LI) Test Point (TP22) | 11 - DIP Switches (SW1) |
| 6 - RF Harvester Input Connector (J6) | 12 - VBATLI or VBAT Selector (J28) |

Figure 2 - Features Needed to Operate the ATM3330e EVB version 3 (ATMEVK-3330e-QN-6)

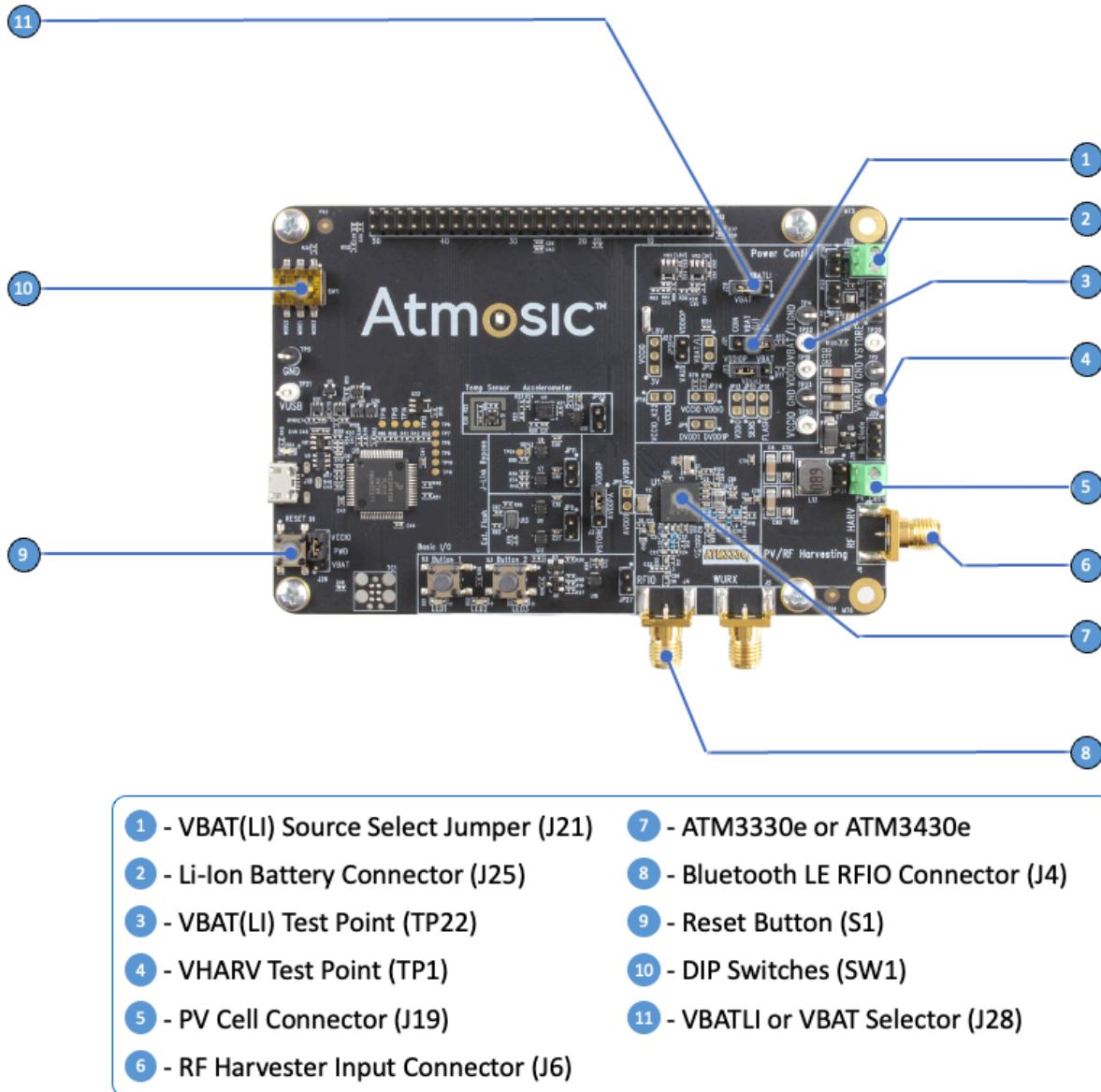
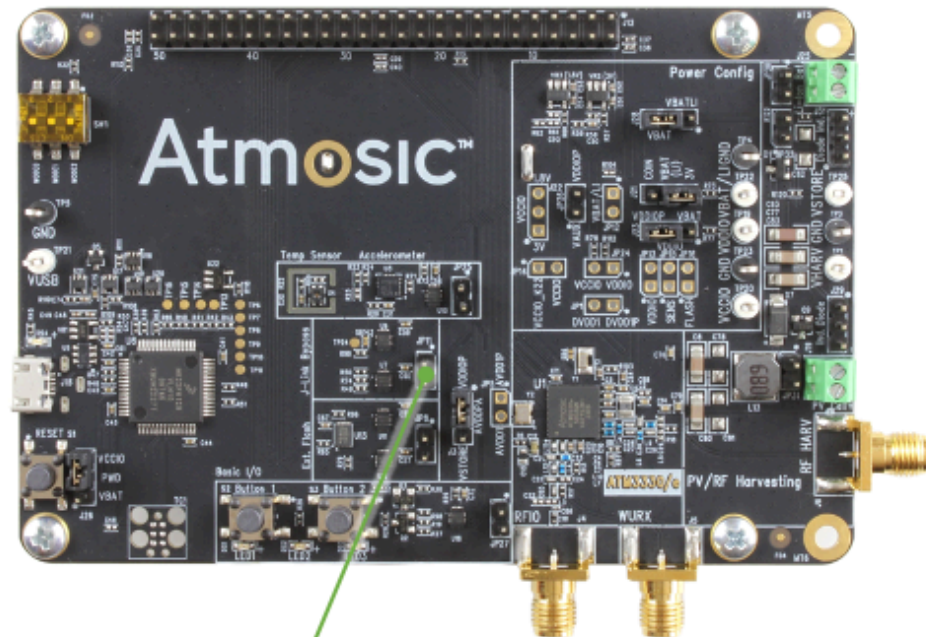

Figure 3 - Features Needed to Operate the ATM3330e EVB version 4 (ATMEVK-3330e-QN-7) and the ATM3430e EVB version 1 (ATMEVK-3430e-WQN-2)

The default jumper settings are suitable for a system with a non-rechargeable battery and internally supplied I/O. The user can refer to the ATM3330/ATM3330e EVB Default Configurations table of the **ATM33/e Series Evaluation Kit User Guide** or the ATM3430/ATM3430e EVB Default Configurations table of the **ATM34/e Series Evaluation Kit User Guide** for a more detailed explanation of the jumper settings and EVB features.

The SMA Connector (HARV) is the input port for RF harvesting, while the Test Point 1 (see [Figure 2](#) and [Figure 3](#), VHARV TP1) or the PV Cell Connector (J19) is the input



J-Link Bypass (JP11)

Figure 5 - EVB Power Measurement Jumpers Configuration - J-Link Bypass, for ATM3330e EVB version 4 (ATMEVK-3330e-QN-7) and the ATM3430e EVB version 1 (ATMEVK-3430e-WQN-2)

3.2 DIP Switches

[Figure 6](#) shows the DIP Switch markings. The marking ON indicates the direction for logical high; the square dot marking indicates the direction for logical low.

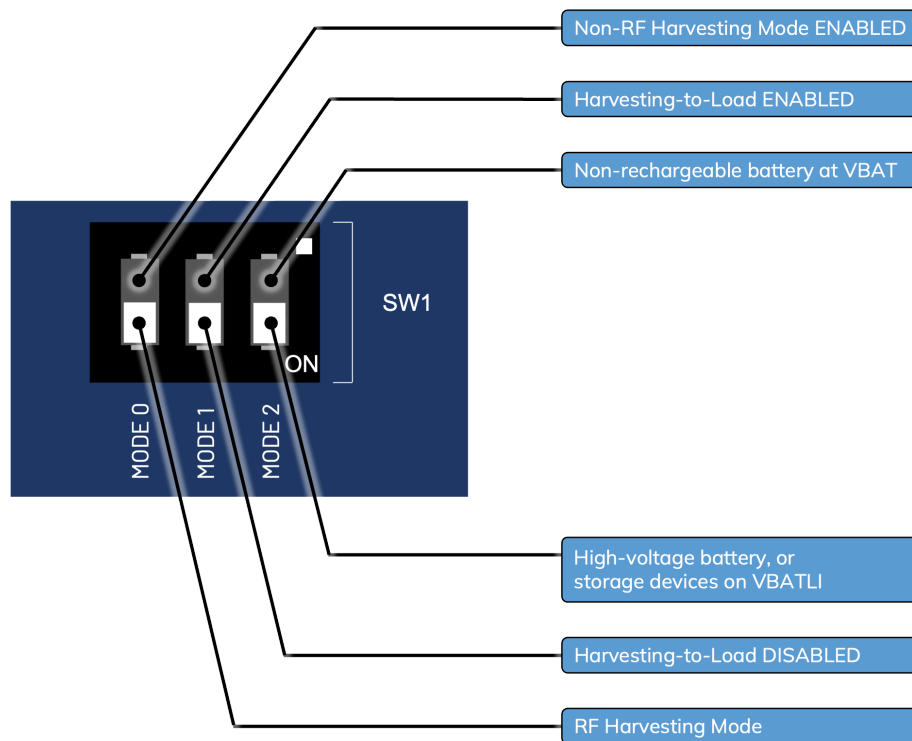

Figure 6 - DIP Switch Marking for ATM3330e/ATM3430e EVBs

The actual GPIO value read by the software is in reverse polarity as the DIP switch on the EVB. The DIP switch has one side connected to the GPIO pin, and the other side connected to the ground. The GPIO is enabled with a weak pullup internally during the software read. When the DIP switch is OFF, the GPIO pin on the board is floating and the software reads a 1; when the DIP switch is ON, the GPIO pin on the board is connected to ground and the software reads a 0.

[Table 3](#) shows all the supported harvesting modes selected by the DIP switches.

MODE2: Battery Type	MODE1: Harvesting to Load	MODE0: Harvesting Type
Non-rechargeable battery at VBAT (DIP switch = OFF, GPIO read = 1)	Enabled (DIP switch = OFF, GPIO read = 1)	Non-RF (DIP switch = OFF, GPIO read = 1)
		RF

MODE2: Battery Type	MODE1: Harvesting to Load	MODE0: Harvesting Type
		(DIP switch = ON, GPIO read = 0)
	Disabled (DIP switch = ON, GPIO read = 0)	Non-RF (DIP switch = OFF, GPIO read = 1)
		RF (DIP switch = ON, GPIO read = 0)
High-voltage battery, or storage devices on VBATLI (DIP switch = ON, GPIO read=0)	N/A	Non-RF (DIP switch = OFF, GPIO read = 1)
		RF (DIP switch = ON, GPIO read = 0)

Table 3 - Harvesting Modes Selection Summary

Table 4 describes the configuration, function, and setting of the DIP switches in detail.

Setting Label	Function	DIP Switch Position ¹	
MODE0	<p>Harvesting Type: RF or PV</p> <p>The PV harvesting voltage range supported by the pre-loaded application is 1.7 V - 2 V, and optimized for the AM-1454 Panasonic PV cell (supplied)</p> <p><i>Note: The SoC supports simultaneous harvesting modes but for evaluation purposes, the pre-loaded application is designed to use only a single mode</i></p>	ON Position OFF Position	RF PV
MODE1	<p>Harvesting to Load</p> <p><u>Disabled:</u> Harvesting power is only used to charge the storage element. VBAT is used to provide power to the load. This mode supports the characterization of the harvesting performance</p> <p><u>Enabled:</u> Harvesting power is used to power the load first, and the remaining</p>	ON Position OFF Position	Disabled Enabled

¹ On = ON, Off = White Square in graphical illustration

Setting Label	Function	DIP Switch Position ¹	
	<p>power is used to charge the storage element. VBAT is used to provide power to the load when the harvesting and stored power are not enough. This is the normal operation mode of the SoC</p> <p><i>Note: This setting is only supported when the MODE2 switch is set to the OFF position (VBAT input).</i></p>		
MODE2	<p>Battery Type</p> <p>ON: Connect a high-voltage battery or storage device at VBATLI to start operation. RF-only or PV-only harvesting settings are enabled based on the MODE0 setting. MODE1 setting is ignored.</p> <p>OFF: Connect a non-rechargeable battery at VBAT to start operation. RF-only or PV-only harvesting settings are enabled based on the MODE0 setting. Harvesting to load is enabled or disabled based on the MODE1 setting.</p>	ON Position	Battery/storage device on VBATLI pin
		OFF Position	Non-rechargeable battery on VBAT pin

Table 4 - Harvesting Mode Selection Details

The default DIP switch settings are all logic low, indicating a system with a non-rechargeable battery and PV harvesting, in normal operation mode.

Note: The EVB must be power cycled before the dip switch settings change to take effect.

3.3 External Charging Booster Configurations on EVK

To evaluate the external charging booster operation of the ATMEVK-3330e version 4 or the ATMEVK-3430e version 1, please refer to [Figure 7](#) for the main components used during the operation.

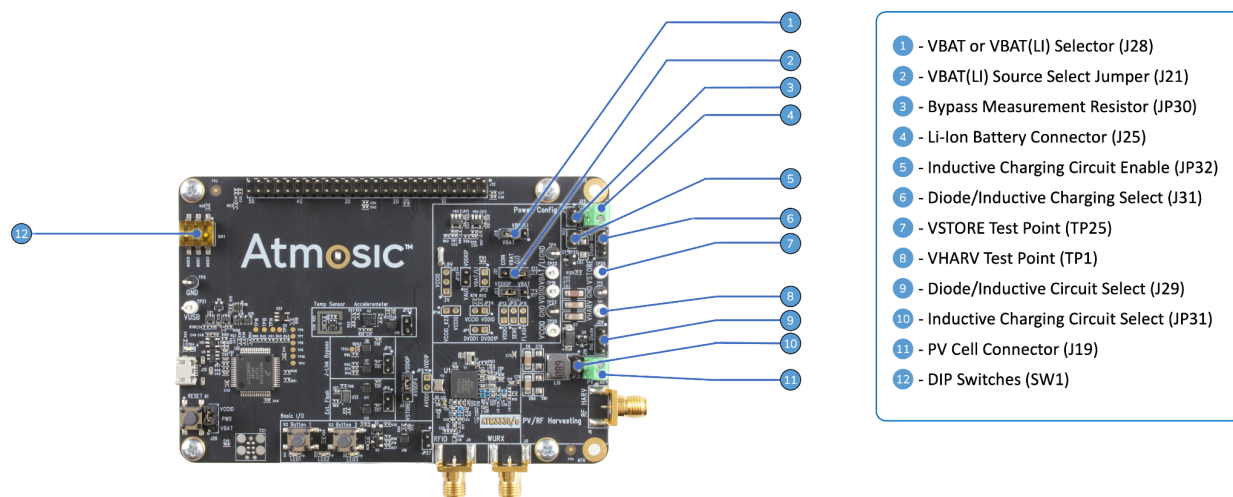

Figure 7 - Operation of ATM3330e EVB version 4 (ATMEVK-3330e-QN-7) and ATM3430e EVB version 1 (ATMEVK-3430e-WQN-2) External Charging Booster - Main Components

During the evaluation of the external charging boosting operation, the 3 DIP switches (SW1) should be set as shown in [Table 5](#) below.

MODE2: Battery Type	MODE1: Harvesting to Load	MODE0: Harvesting Type
High-voltage battery, or storage devices on VBATLI (DIP switch = ON, GPIO read=0)	Enabled (DIP switch = OFF, GPIO read = 1)	Non-RF (DIP switch = OFF, GPIO read = 1)

Table 5 - 3 DIP Switches Settings for Evaluating External Charging Boosting Options

There are 3 PV harvesting external charging booster configurations:

1. Inductive boost from Vharv (default firmware loaded in EVB)
2. 2-diode boost from Vstore (requires firmware update)
3. 2-diode boost from Vharv (requires firmware update)

For firmware build details on configurations 2 and 3 listed above, please refer to **ATM33/e ATM34/e Support for External Energy Storage Devices Application Note.**

[Table 6](#) shows the jumper settings for these booster configurations on the V4 EVB.

Booster Options	Firmware	JP31	JP32	J29	J31	J28	J21	JP30	JP31-JP32
1	IB-VH	Install	Install	Install 2-3	Install 2-3	Install 1-2	Open	Install	Open
2	DB-VS	Open	Open	Install 1-2	Install 1-2	Install 1-2	Open	Install	Open
3	DB-VH	Open	Open	Install 1-2	Install 1-2	Install 1-2	Open	Install	connect JP31.1 to JP32.1

Table 6 - Jumper Configurations for Three External Charging Boosting Options

CAUTION:

When evaluating the PV harvesting with external charging booster functions, *please do not disconnect the Li-Ion battery or Hybrid supercapacitor(HSC) abruptly from the battery connector (J25) when PV harvesting is operating.* If you need to remove the Li-Ion battery, please remove the jumper of J29 to stop the PV harvesting function first, then you can safely remove the Li-Ion battery from the battery connector (J25).

3.4 Power Cycling the EVB

The Reset Button (S1) can be used for power cycling the board.

4. Setup with RF Sources

When evaluating RF harvesting, the MODE0 DIP switch should be set to a logical high for optimal RF performance.

4.1 RF Source Transmitter Board

Atmosic provides a 915 MHz RF energy source for RF harvesting evaluation as shown in [Figure 9](#). This RF Source Transmitter board must be ordered separately and is shown on the right of the figure with the ATM3330e Energy Harvesting EVB on the left.

When the RF energy source is plugged in using the provided 5 V AC adapter, it will transmit a continuous +30 dBm GFSK modulated signal at 915 MHz. Due to the high output power, developers are advised to connect the 915 MHz antenna to the SMA connector labeled J6 on the RF Source Transmitter board before powering it on. It is normal for the RF Source board to become warm during prolonged operation. Please refer to the **RF Source Transmitter Board User Guide** for more information.

On the EVB, the 915 MHz antenna should be connected to the SMA connector labeled HARV, and the 2.4 GHz antenna should be connected to the SMA connector labeled RFIO. See [Figure 8](#).

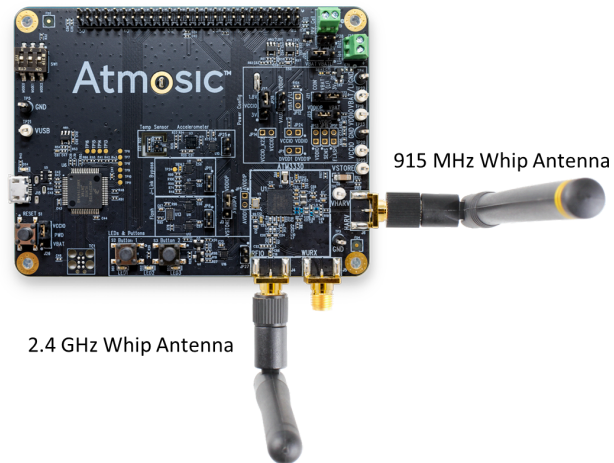

Figure 8 - Antenna Connection (ATM3330e version 3 EVK is shown as an example)

The EVB should be placed roughly 12 inches from the energy source board as shown in [Figure 9](#). Please note there should be a battery in the EVB for operations.

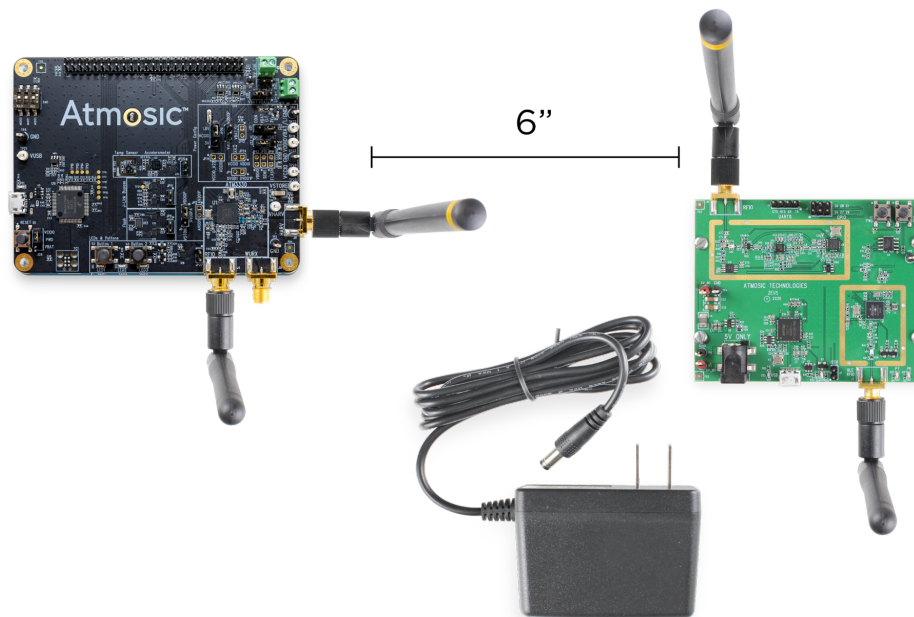

Figure 9 - EVB (Left) Setup with RF Source Transmitter (Right) (ATM3330e version 3 EVK is shown as an example)

The advertisement beacons are detectable with any Bluetooth LE sniffer application. As an example, a ViewTool Hollong Bluetooth LE Sniffer is used and the screenshot is shown in [Figure 10](#). The scan response of the beacon shows ATM3 RF.

Note: Do not continuously operate the RF Source Transmitter with the RF output power set at +30 dBm (default) at a distance closer than 6 inches to the harvesting antenna of the EVB. At this distance, the RF energy input to the harvester will exceed the maximum input specification for the Atmosic device and may cause permanent damage. If it is desired to operate with the RF Source Transmitter closer than 6 inches, the transmitter power can be lowered. Refer to the **RF Source Transmitter Board User Guide** for instructions.

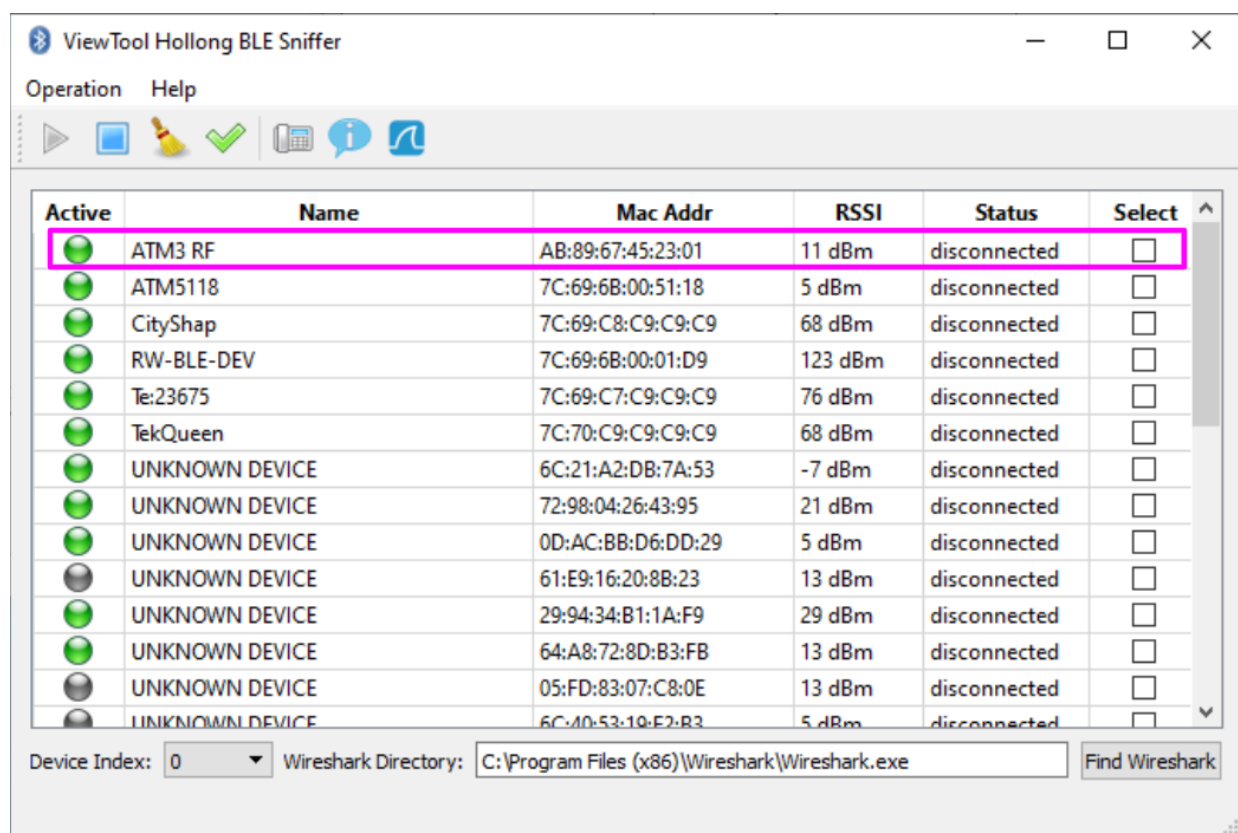

Figure 10 - EVB Detected by ViewTool Hollong Bluetooth LE Sniffer

5. Setup with PV Source

When using a PV cell as the harvesting source to the EVB, the MODE0 DIP switch should be set low for optimal performance. Connect the positive terminal of the PV cell to the PV Cell Connector test point and its negative terminal to the GND test point of the Li-Ion Battery Connector (J25) as shown in [Figure 11](#) and [Figure 12](#). For demonstration and evaluation purposes, a PV cell by Panasonic suitable for indoor environments is included in the EVK.

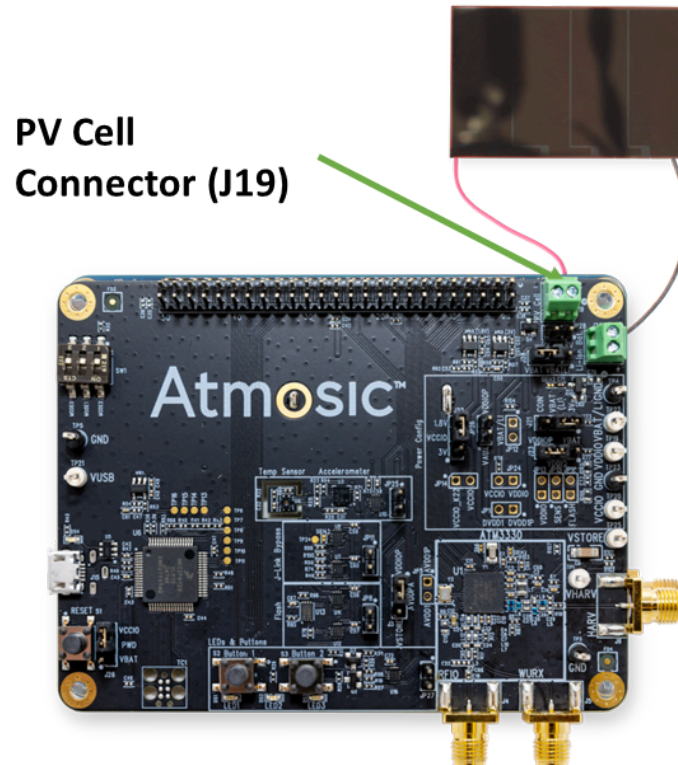

Figure 11 - EVB Setup with PV Cell, for ATM3330e EVB version 3 (ATMEVK-3330e-QN-6)

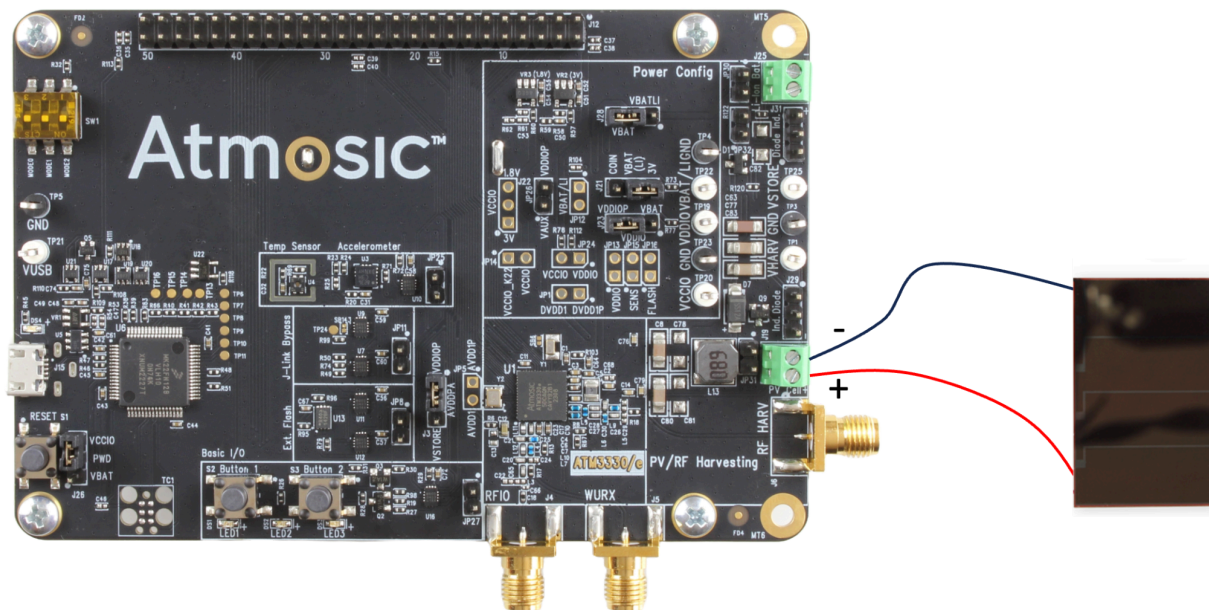

Figure 12 - EVB Setup with PV Cell, for ATM3330e EVB version 4 (ATMEVK-3330e-QN-7) and the ATM3430e EVB version 1 (ATMEVK-3430e-WQN-2)

The advertisement beacons are detectable with any Bluetooth LE sniffer application. As an example, a ViewTool Hollong Bluetooth LE Sniffer is used and the screenshot is shown in [Figure 13](#). The scan response of the beacon shows ATM PV. Please note there should be a battery in the EVB for operations.

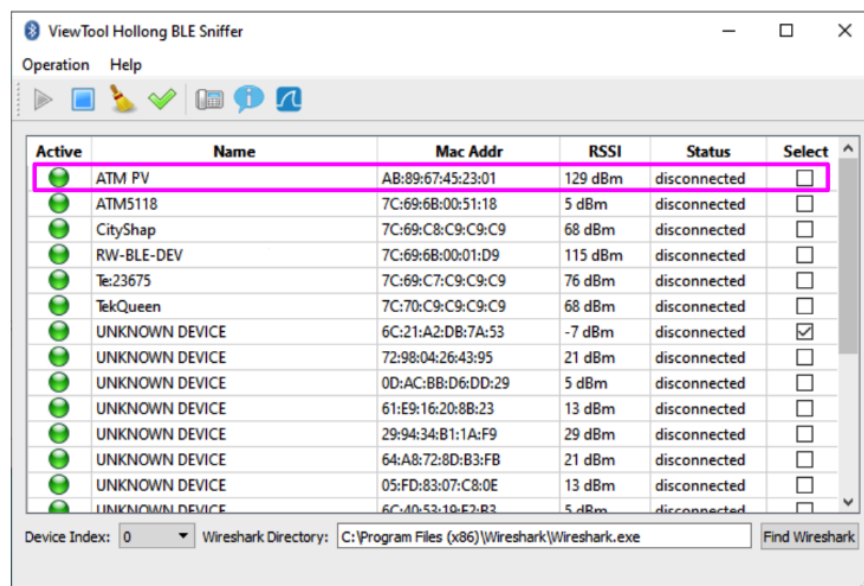

Figure 13 - EVB Detected by ViewTool Hollong Bluetooth LE Sniffer

Reference Documents

Title	Document Number
ATM33e/ATM34e Series Energy Harvesting Application Note	4269-xxxx-xxxx
ATM33/e/ATM34e Support for External Energy Storage Devices Application Note	4266-xxxx-xxxx
ATM33/e Series Evaluation Kit User Guide	ATM33_e-UGEVK
ATM34/e Series Evaluation Kit User Guide	6441-xxxx-xxxx
RF Source Transmitter Board User Guide	ATM3xxx-UGTB

Revision History

Date	Version	Description
July 19, 2024	0.66	Added configuration and instructions for ATM3430e EVK
February 14, 2024	0.65	Updated title and footer. No content change.
January 31, 2024	0.64	Added new section 3.3 - External Charging Booster Configurations on Version 4 EVK . Updated Figure 2 - Features Needed to Operate the ATM3330e EVB version 3... , Figure 3 - Features Needed to Operate the ATM3330e EVB version 4... , Figure 5 - EVB Power Measurement Jumpers Configuration - J-Link... , Figure 7 - Operation of ATM3330e EVB version 4 (ATMEVK-...) , Table 1 - Applicable SoC and EVK
March 10, 2023	0.63	Added Hardware and Software Requirements section, Figure 3 - EVB Power Measurement Jumpers Configuration - J-Link Bypass . Updated Overview , Figure 1 - Items included in the ATM3330e EVK , Connecting to the EVB , Figure 2. Features Needed to Operate the ATM3330e EVB , DIP Switches , Setup with PV Source sections, Table 3 - Harvesting Mode Selection , Figure 4 - DIP Switch Marking for ATM3330e , Figure 5 - Antenna Connection , Figure 8 - EVK Setup with PV Cell .
August 31, 2022	0.62	Updated Setup with PV Source section.
August 15, 2022	0.61	Updated Figure 1 - Items included in the ATM3330e Evaluation Kit (EVK) , Figure 2 - Features Needed to Operate the ATM3330e EVB , Figure 3 - DIP Switch Marking for ATM3330e , Figure 5 - EVK (Right) Setup with RF Source Transmitter (Left) Table 1 - Harvesting Mode Selection . Added Figure 4 - Antenna Connection . Corrected typos.
February 15, 2022	0.60	Updated various sections throughout the document.
December 3, 2021	0.51	Changed part number, no content change.
November 9, 2021	0.50	Initial version created.



ATMOSIC TECHNOLOGIES – DISCLAIMER

This product document is intended to be a general informational aid and not a substitute for any literature or labeling accompanying your purchase of the Atmosic product. Atmosic reserves the right to amend its product literature at any time without notice and for any reason, including to improve product design or function. While Atmosic strives to make its documents accurate and current, Atmosic makes no warranty or representation that the information contained in this document is completely accurate, and Atmosic hereby disclaims (i) any and all liability for any errors or inaccuracies contained in any document or in any other product literature and any damages or lost profits resulting therefrom; (ii) any and all liability and responsibility for any action you take or fail to take based on the information contained in this document; and (iii) any and all implied warranties which may attach to this document, including warranties of fitness for particular purpose, non-infringement and merchantability. Consequently, you assume all risk in your use of this document, the Atmosic product, and in any action you take or fail to take based upon the information in this document. Any statements in this document in regard to the suitability of an Atmosic product for certain types of applications are based on Atmosic's general knowledge of typical requirements in generic applications and are not binding statements about the suitability of Atmosic products for any particular application. It is your responsibility as the customer to validate that a particular Atmosic product is suitable for use in a particular application. All content in this document is proprietary, copyrighted, and owned or licensed by Atmosic, and any unauthorized use of content or trademarks contained herein is strictly prohibited.

Copyright ©2021-2023 by Atmosic Technologies. All rights reserved. Atmosic logo is a registered trademark of Atmosic Technologies Inc. All other trademarks are the properties of their respective holders.

Atmosic™

Atmosic Technologies | 2105 S. Bascom Ave. | Campbell CA, 95008

www.atmosic.com