

ATM33/e Series Evaluation Kit

User Guide

SUMMARY: This guide provides an overview of the ATM33/ATM33e Wireless SoC Series Evaluation Kit (EVK), power up instructions, hardware and Windows® driver configurations.



Atmosic™

Doc. No. ATM33_e-UGEVK-0067

Table of Contents

User Guide	1
Table of Contents	2
List of Figures	3
List of Tables	4
Acronyms and Abbreviations	5
1. Overview	6
2. Hardware and Software Requirements	6
2.1 Supported EVK	6
2.2 Supported SDK	7
3. ATM33/e EVK Description	7
3.1 ATM33/e EVB General Description	8
3.2 ATM3330/e EVB v3.x Description	9
3.3 ATM3330/e EVB v4.x Description	17
3.3.1 Boosting Circuit Configuration on ATM3330/e EVB v4.x	26
3.4 ATM3325 EVB Description	26
3.5 ATM3325 with Extended Storage EVB Description	35
3.6 ATM3325 WLCSP EVB Description	44
3.7 EVB Reconfiguration	52
4. VDDIO Voltage	52
5. Powering on the EVB via the USB Connector	53
6. Windows Driver Configurations	53
7. Reconfigure the EVB	55
Reference Documents	56
Revision History	57

List of Figures

- Figure 1 - ATM33/e Evaluation Kit Components
- Figure 2 - ATM3330/e 7x7 mm Package v3.x EVB Overview
- Figure 3 - ATM3330/e 7x7 mm Package v3.x EVB Jumper Locations
- Figure 4 - ATM3330/e 7x7 mm Package v3.x EVB Top Silkscreen
- Figure 5 - ATM3330/e 7x7 mm Package v4.x EVB Overview
- Figure 6 - ATM3330/e 7x7 mm Package v4.x EVB Jumper Locations
- Figure 7 - ATM3330/e 7x7 mm Package v4.x EVB Top Silkscreen
- Figure 8 - ATM3325 5x5 mm Package v3.x EVB Overview
- Figure 9 - ATM3325 5x5 mm Package v3.x EVB Jumper Locations
- Figure 10 - ATM3325 5x5 mm Package v3.x EVB Top Silkscreen
- Figure 11 - ATM3325 with Extended Storage 5x5 mm Package v3.x EVB Overview
- Figure 12 - ATM3325 with Extended Storage 5x5 mm Package v3.x EVB Jumper Locations
- Figure 13 - ATM3325 with Extended Storage 5x5 mm Package v3.x EVB Top Silkscreen
- Figure 14 - ATM3325 WLCSP 49L Package v3.x EVB Overview
- Figure 15 - ATM3325 WLCSP 49L Package v3.x EVB Jumper Locations
- Figure 16 - ATM3325 WLCSP 49L Package v3.x EVB Top Silkscreen
- Figure 17 - Correct Windows Driver for the EVB

List of Tables

Table 1 - Applicable SoCs and EVKs

Table 2 - ATM3330/e 7x7 mm Package v3.x EVB Main Components Descriptions

Table 3 - ATM3330/e 7x7 mm Package v3.x EVB Jumpers Descriptions

Table 4 - ATM3330/e 7x7 mm Package v3.x EVB Default Configurations

Table 5 - ATM3330/e 7x7 mm Package v4.x EVB Main Components Descriptions

Table 6 - ATM3330/e 7x7 mm Package v4.x EVB Jumpers Descriptions

Table 7 - ATM3330/e 7x7 mm Package v4.x EVB Default Configurations

Table 8 - ATM3330e v4.x EVB Boosting Options Jumper Configurations

Table 9 - ATM3325 5x5 mm Package v3.x EVB Main Components Descriptions

Table 10 - ATM3325 5x5 mm Package v3.x EVB Jumpers Descriptions

Table 11 - ATM3325 5x5 mm Package v3.x EVB Default Configurations

Table 12 - ATM3325 with Extended Storage 5x5 mm Package v3.x EVB Main Components Descriptions

Table 13 - ATM3325 with Extended Storage 5x5 mm Package v3.x EVB Jumpers Descriptions

Table 14 - ATM3325 with Extended Storage 5x5 mm Package v3.x EVB Default Configurations

Table 15 - ATM3325 WLCSP 49L Package v3.x EVB Main Components Descriptions

Table 16 - ATM3325 WLCSP 49L Package v3.x EVB Jumpers Descriptions

Table 17 - ATM3325 WLCSP 49L Package v3.x EVB Default Configurations

Acronyms and Abbreviations

Acronyms	Definition
ATM33/e	ATM3325 ATM3330 ATM3330e
ATM3330/e	ATM3330 ATM3330e
EVB	Evaluation Board
EVK	Evaluation Kit
LDO	Low Drop Out
OB	On Board
PA	Power Amplifier
SDK	Software Development Kit
SoC	System-on-Chip

1. Overview

The EVK for ATM33/e Wireless SoC Series enables developers to:

- Evaluate ATM33/e Bluetooth Low Energy SoC features and energy harvesting functionality and performance
- Run basic example applications from the SDK, that use on-board temperature, humidity, and motion sensors
- Debug with J-Link OB debugger without using an external J-link dongle. The Segger J-link license is included as part of the EVB. It is a handy development and debug tool
- Measure ATM33/e device power consumption
- Prototype applications on the ATM33/e

This document provides an overview of the available EVKs, EVBs, power up instructions, hardware and Windows driver configurations.

See [Reference Documents](#) section for related documents.

Documents are available on the Atmosic Support website, [submit a support request](#) for access credentials.

2. Hardware and Software Requirements

2.1 Supported EVK

This document is applicable to:

EVK	SoC Package	SoC Part Number	Kit Part Number
Evaluation Kit for ATM3325	40-pin 5x5 mm QFN	ATM3325-5DCAQK	ATMEVK-3325-QK
Evaluation Kit for ATM3325 with Extended Storage	40-pin 5x5 mm QFN	ATM3325-5LCAQK	ATMEVK-3325-LQK
Evaluation Kit for ATM3330	56-pin 7x7 mm QFN	ATM3330-5DCAQN	ATMEVK-3330-QN
Evaluation Kit for ATM3330e	56-pin 7x7 mm QFN	ATM3330E-5DCAQN	ATMEVK-3330e-QN

Table 1 - Applicable SoCs and EVKs

2.2 Supported SDK

The Atmosic SDK 5.3.0 or later can be used with the EVK. Refer to the **SDK User Guide** for more information.

3. ATM33/e EVK Description

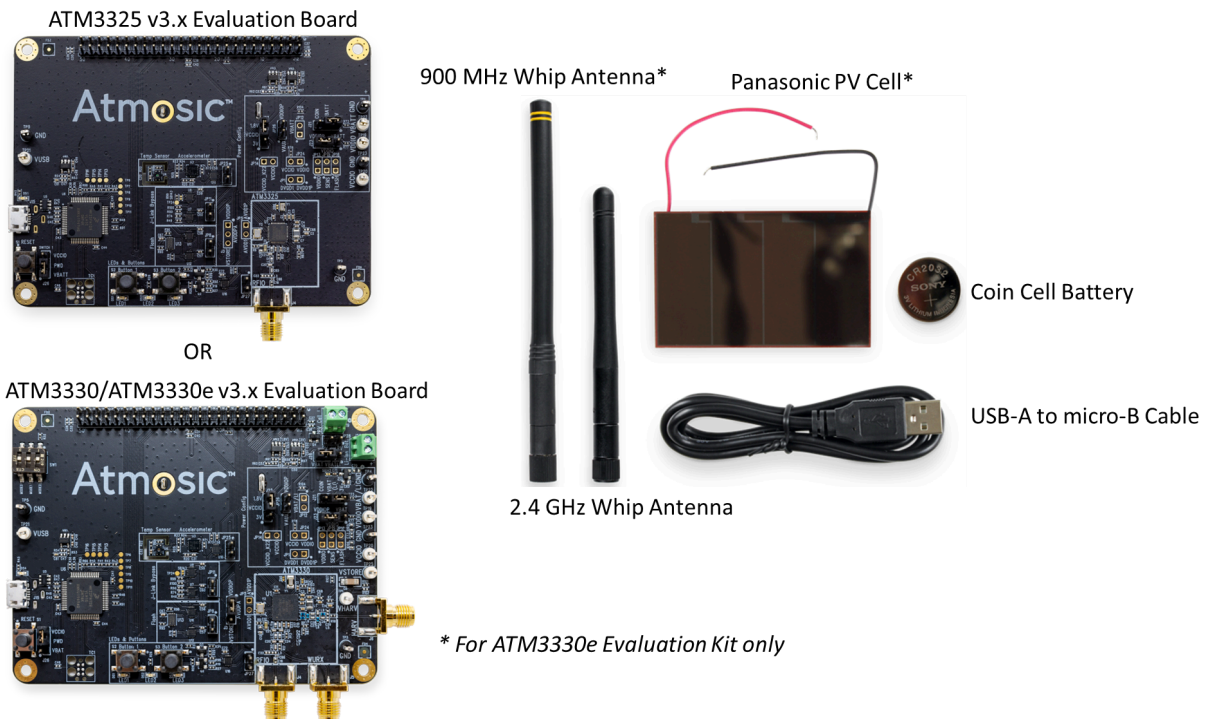

Figure 1 - ATM33/e Evaluation Kit Components

3.1 ATM33/e EVB General Description

[Figure 2](#) highlights some of the key components of the ATM3330/e EVB. [Table 2](#) provides the descriptions of the labeled components.

All components, except for the CR2032-sized battery holder, are on the top side of the board.

The jumper settings as shown in the figure have been configured for typical operation where battery voltage (VBAT) for the ATM3330/e is supplied by the on-board 3.0 V linear LDO regulator.

The I/O voltage (VDDIO) of the ATM3330/e is internally supplied by VDDIOP, and the supply voltage of the EVB management processor (MK22N) and the sensors are tied to the on-board 1.8 V linear LDO regulator.

3.2 ATM3330/e EVB v3.x Description

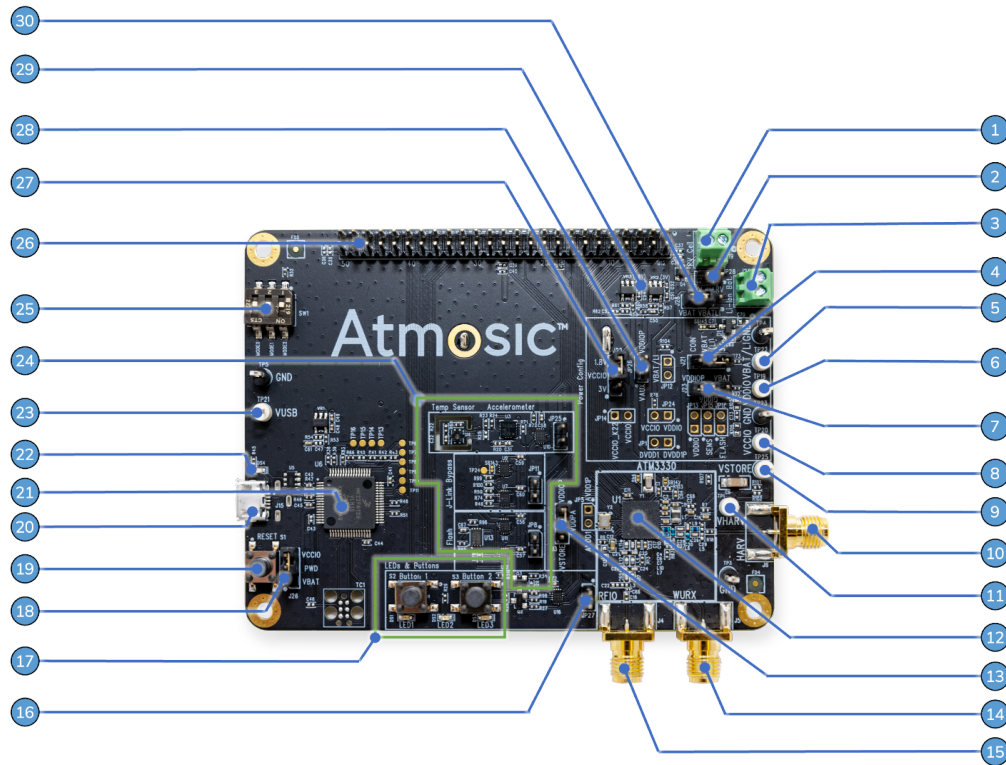

- | | |
|-----------------------------------|---------------------------------------|
| 1 - PV Cell Connector | 16 - LED/Button Enable Jumper |
| 2 - Concurrent Harvesting Enable | 17 - General Purpose I/O |
| 3 - Li-Ion Battery Connector | 18 - Reset Voltage Select Jumper |
| 4 - VBAT(LI) Source Select Jumper | 19 - Reset Button (S1) |
| 5 - VBAT(LI) Test Point (TP22) | 20 - Micro-B USB Connector |
| 6 - VDDIO Test Point (TP19) | 21 - EVB Management Processor (MK22N) |
| 7 - VDDIO Select Jumper | 22 - USB Power LED |
| 8 - VCCIO Test Point (TP20) | 23 - USB Power Test Point (TP21) |
| 9 - VSTORE Test Point (TP25) | 24 - Peripherals & Enable Jumpers |
| 10 - RF Harvester Input Connector | 25 - DIP Switches (3) |
| 11 - VHARV Test Point (TP1) | 26 - 50-Pin Expansion Header |
| 12 - ATM3330e | 27 - VCCIO Select Jumper |
| 13 - PA Supply Select Jumper | 28 - VDDIOP Disable |
| 14 - Wake Up Receiver Connector | 29 - 1.8V/3.0V LDOs |
| 15 - Bluetooth LE RFIO Connector | 30 - VBAT / VBATLI Select |
- LED1: RED
LED2: YELLOW
LED3: BLUE

Push Button 1: (S2)
Push Button 2: (S3)
- Flash: JP8
J-Link Bypass: JP11
Sensors: JP25

Figure 2 - ATM3330/e 7x7 mm Package v3.x EVB Overview

Item	Component	Description
1	PV Cell Connector	<ul style="list-style-type: none"> Connect a PV Cell to the board. Note that the polarity of the connector is marked in white silkscreen. Insert the corresponding leads of the PV Cell into the connector and secure the leads by turning the screws clockwise until it's tight.
2	Concurrent Harvesting Enable	<ul style="list-style-type: none"> Install JP28 when a PV Cell is used and connected to the board through the PV Cell Connector (J19) to enable concurrent RF and PV harvesting. <p>Note: For now, JP28 should be left open because this concurrent harvesting feature has not yet been implemented.</p>
3	Li-Ion Battery Connector	<ul style="list-style-type: none"> Connect a Li-Ion battery or Hybrid Supercapacitor to the board. Note that the polarity of the connector is marked in white silkscreen. Insert the corresponding leads of the Li-Ion battery or Hybrid Supercapacitor into the connector and secure the leads by turning the screws clockwise until it's tight.
4	VBAT(LI) Source Select Jumper	<ul style="list-style-type: none"> Select COIN if a coin cell battery is installed in the holder BT2 mounted on the back of the board and battery operation is desired. Select 3 V if USB is connected and regulated 3.0 V operation (VBAT or VBATLI) is desired. Select neither (no jumper) if an external supply (1.1 V - 3.3 V) is connected to TP22. <p>This option is used for power profiling of ATM3330/ATM3330e or when a supply voltage other than 3.0 V for VBAT or VBATLI is desired.</p>
5	VBAT(LI) Test Point (TP22)	<ul style="list-style-type: none"> Provide external VBAT or VBATLI voltage directly to the ATM3330/e, or When an arbitrary VBAT voltage (different from 3 V) is desired. <p>Note: When TP22 is used, no jumper should be installed on J21.</p>
6	VDDIO Test Point (TP29)	<ul style="list-style-type: none"> Provide external VDDIO voltage directly to the ATM3330/e. <p>Note: When TP29 is used, no jumper should be installed on J23.</p>
7	VDDIO Select Jumper	<ul style="list-style-type: none"> Select VDDIOP if internally generated 1.8 V by the ATM3330/e is used for I/O voltage. <ul style="list-style-type: none"> Install VCCIO Select Jumper J22 (see below) accordingly. Select VBAT if external VDDIO equal to VBAT is desired for I/O voltage. <ul style="list-style-type: none"> Install VCCIO Select Jumper J22 (see below) accordingly.

Item	Component	Description
		<ul style="list-style-type: none"> ○ Install JP26 (to connect VDDIOP to VAUX) if VDDIOP is not used to power the PA (J3) for output power greater than 4dBm ● Select neither (no jumper) if an external supply (1.8 V - 3.3 V) is connected to TP19. <ul style="list-style-type: none"> ○ Install JP26 (to connect VDDIOP to VAUX) if VDDIOP is not used to power the PA (J3) for output power greater than 4dBm
8	VCCIO Test Point (TP20)	<ul style="list-style-type: none"> ● Provide external VCCIO voltage for the peripheral devices on the board instead of using the LDO's. ● Used when the VDDIO of the ATM3330/e is other than 1.8 V or 3 V. ● This external VCCIO supply voltage needs to match the external VDDIO voltage on TP19. <p><i>Note: When TP20 is used, no jumper should be installed on J22.</i></p>
9	VSTORE Test Point (TP25)	<ul style="list-style-type: none"> ● For monitoring the harvested energy level when PV or RF harvesting is enabled.
10	RF Harvester Input Connector	<ul style="list-style-type: none"> ● For connection to an antenna, or to an instrument for conducted measurements. ● The current matching components on the EVB are tuned for 915 MHz and can be modified to match to other frequencies such as 2400 MHz.
11	VHARV Test Point (TP1)	<ul style="list-style-type: none"> ● For connection to a digital multimeter (DMM) to monitor the output voltage of the ATM3330e's RF rectifier, or ● For connection to a photovoltaic (PV) cell or other energy harvesting devices as an input.
12	ATM3330e	7x7 mm QFN 56-pin package with center GND pad
13	PA Supply Select Jumper	<ul style="list-style-type: none"> ● Select nothing (no jumper) if Bluetooth LE transmit power is 4 dBm or lower. ● Select VDDIOP if Bluetooth LE transmit power is greater than 4 dBm and 1.8 V supply for the internal Power Amplifier is desired. ● Select VSTORE if Bluetooth LE transmit power is greater than 4 dBm and a voltage supply other than 1.8 V is used for the internal Power Amplifier. Note that this option is reserved for future power efficiency optimization and currently has not yet been thoroughly verified.

Item	Component	Description
14	Wake Up Receiver Connector	<ul style="list-style-type: none"> For connection to an antenna The current matching components on the EVB are tuned for 2400 MHz and can be modified to match to other frequencies such as 900 MHz.
15	Bluetooth LE RFIO Connector	<ul style="list-style-type: none"> For connection to a 2.4 GHz antenna, or An instrument (network analyzer, spectrum analyzer, Bluetooth LE tester)
16	LED/Button Enable Jumper	<ul style="list-style-type: none"> Install JP27 to enable functionality of the LEDs: <ul style="list-style-type: none"> LED1 : RED LED2 : YELLOW LED3 : BLUE Button 1 : S2 Button 2 : S3
17	General Purpose I/O	2 Buttons and 3 LEDs controlled by GPIOs of ATM3330/e
18	Reset Voltage Select Jumper	<ul style="list-style-type: none"> Select VBAT if VCCIO is not available (USB is not connected) Select VCCIO if USB is connected and accurate power-down ATM3330/ATM3330e current measurement is required.
19	Reset Button (S1)	To assert PWD to the ATM3330/e (pin 16) to reset the ATM3330/ATM3330e.
20	Micro-B USB Connector	Provide power to the EVB.
21	EVB Management Processor (MK22N)	<ul style="list-style-type: none"> Used as a translation between USB and UART and SWD. Note: the main supply voltage level of this processor needs to match that of the IO supply of the ATM3330/e.
22	USB Power LED	Green LED lights up when the EVB is connected to a computer through the USB connector.
23	USB Power Test Point (TP21)	<ul style="list-style-type: none"> TP21 can be used to supply the board with an external 5 V in the case where a USB connection to the board is not available. <p>Note: TP21 should not be used concurrently with a USB connection to a host laptop.</p>
24	Peripheral & Enable Jumpers	<p>Enable for Flash (JP8), J-Link bypass (JP11), and Sensors (JP25)</p> <ul style="list-style-type: none"> Install JP8 to enable external Flash. Install JP11 to disconnect the MK22N microcontroller I/O lines

Item	Component	Description
		<p>(SWD, UARTs) from the GPIOs of the ATM3330/e by switching the analog switches (U7, U9).</p> <ul style="list-style-type: none"> ○ This option is useful for accurate power profiling of the ATM3300/e without interference from the MK22N. ● Install JP25 to enable the temperature sensor and accelerometer. <ul style="list-style-type: none"> ○ ENS210 Temperature and Humidity Sensor <ul style="list-style-type: none"> ■ Used by the demo application “HT_thermometer” or Sensor Beacon to demonstrate the ability of the ATM3300/e to retrieve temperature and humidity information from the sensor to facilitate software development. ○ LIS3DH Motion Sensor <ul style="list-style-type: none"> ■ Used by demo application “lis2dh12_demo” to demonstrate the ability of the ATM3300/e to retrieve motion information from the sensor to facilitate software development.
25	DIP Switches (3)	<ul style="list-style-type: none"> ● For selecting different harvesting modes (Mode0, Mode1, Mode2) by pulling the GPIOs P11, P14, or P24 low through the resistor R32. ● If harvesting is not used, these switches can be ignored.
26	50-Pin Expansion Header	<ul style="list-style-type: none"> ● For connection to test instruments. ● All the GPIOs are by default available on this header.
27	VCCIO Select Jumper	<ul style="list-style-type: none"> ● Select 1.8 V if VDDIOP is selected for VDDIO (J23) (see #7 above). ● Select 3 V if VBAT is selected for VDDIO (J23) (see #7 above). ● Select neither (no jumper) if VDDIO is supplied externally through TP19. In this case, the same external voltage supply needs to connect to TP20 (see #8 above).
28	VDDIOP Disable Jumper (JP26)	<ul style="list-style-type: none"> ● Install this Jumper JP26 when VDDIOP is not used to power VDDIO (J23) (see #7 above). <p><i>Note: Install only if VDDIOP is not used to power the PA (J3) for output power greater than 4dBm</i></p>
29	1.8 V / 3.0 V LDOs	<ul style="list-style-type: none"> ● Supply voltages to the ATM3330/e and other peripheral components using either 1.8 V or 3.0 V. ● These LDO's are powered by the USB power through the USB connector.

Item	Component	Description
30	VBAT or VBATLI Select (J28)	<ul style="list-style-type: none"> Select VBAT to power the ATM3330/e via the VBAT pin 20. Select VBATLI to power the ATM3330/e via the VBATLI pin 28.

Table 2 - ATM3330/e 7x7 mm Package v3.x EVB Main Components Descriptions

In addition to the configurable jumpers described above, there are a few other jumpers on the board that are not installed by default because they are not normally needed for typical use. All these jumpers except one JP24 are shorted by default through solder bridges located immediately below them on the back side of the board. These jumpers can be seen in [Figure 3](#). See [Table 3](#) for descriptions of these jumpers.

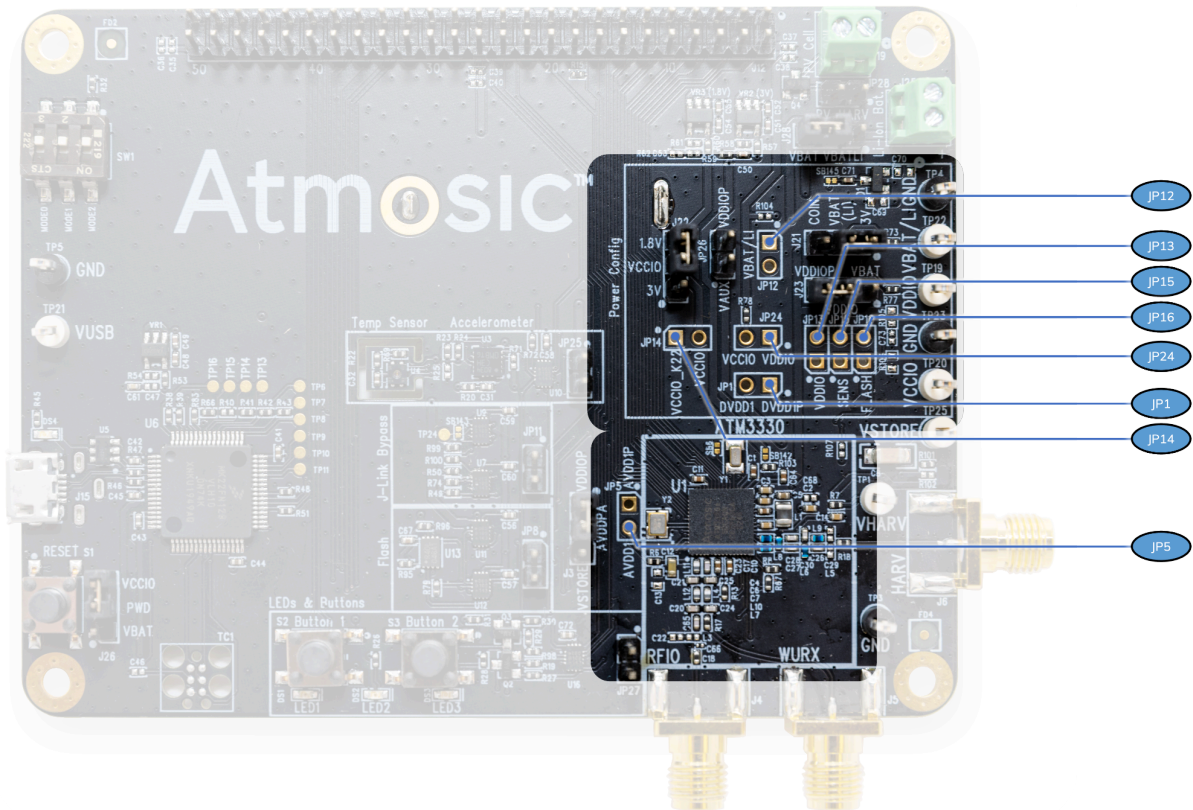

Figure 3 - ATM3330/e 7x7 mm Package v3.x EVB Jumper Locations

Jumper	Solder Bridge	Description
JP12	SB136	<ul style="list-style-type: none"> In series with the net VBAT and is shorted by the solder bridge SB136 on the back side. SB136 can be cut to allow for current measurements on VBAT.
JP13	SB137	<ul style="list-style-type: none"> In series with the net VDDIO and is shorted by the solder bridge SB137 on the back side. SB137 can be cut to allow for current measurements on VDDIO.
JP15	SB140	<ul style="list-style-type: none"> In series with the net VDDIO_SENS and is shorted by the solder bridge SB140 on the back side. SB140 can be cut to allow for measurements of currents drawn by the sensors.
JP16	SB141	<ul style="list-style-type: none"> In series with the net VDDIO_FLASH and is shorted by the solder bridge SB141 on the back side. SB141 can be cut to allow for measurements of currents drawn by the external flash.
JP24	N/A	<ul style="list-style-type: none"> By default not installed and not shorted by a solder bridge. If installed, it would connect the peripheral supply VCCIO with the ATM33/e VDDIO supply, useful for the case where USB supply is not available.
JP1	SB2	<ul style="list-style-type: none"> In series with the net DVDD1 and is shorted by the solder bridge SB2 on the back side. SB2 can be cut to allow for current measurements on DVDD1.
JP14	SB138	<ul style="list-style-type: none"> In series with the net VCCIO_K22 and is shorted by the solder bridge SB138 on the back side. SB138 can be cut to allow for measurements of currents drawn by the MK22N processor.
JP5	SB9	<ul style="list-style-type: none"> In series with the net AVDD1 and is shorted by the solder bridge SB9 on the back side. SB9 can be cut to allow for current measurements on AVDD1.

Table 3 - ATM3330/e 7x7 mm Package v3.x EVB Jumpers Descriptions

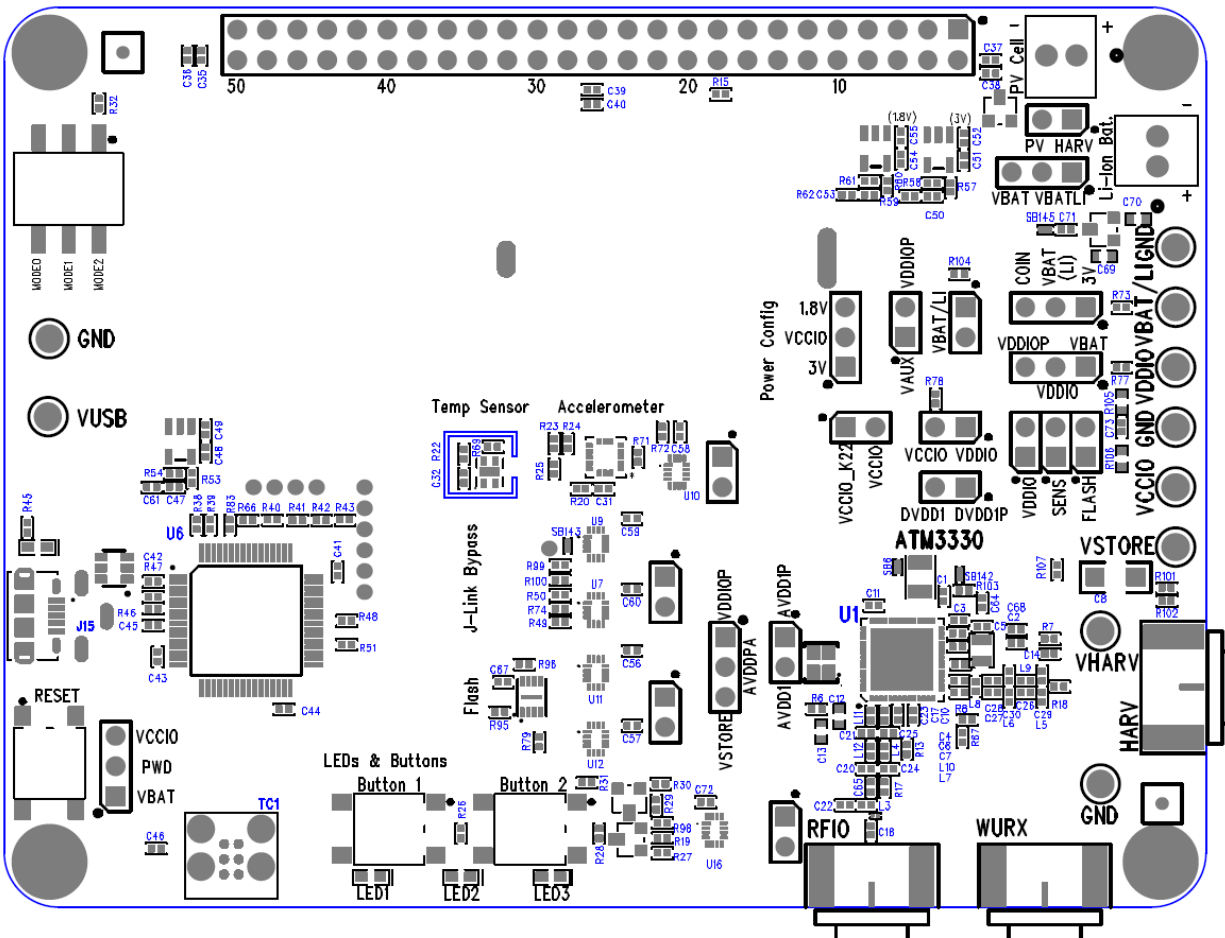

Figure 4 - ATM3330/e 7x7 mm Package v3.x EVB Top Silkscreen

The jumpers on the EVB have been configured for the following default mode of operation. See [Table 4](#).

Default Configuration	Jumper
The ATM33/e is powered through its VBAT pin 20	J28
The ATM33/e's main supply VBAT comes from the coin cell battery	J21
The ATM33/e uses internal I/O voltage supplied by 1.8 V VDDIOP	J23
Peripheral supply VCCIO is connected to 1.8 V LDO	J22
External flash is NOT powered and NOT connected to the ATM33/e GPIOs	JP8 not installed
Sensors are NOT powered and NOT connected to the ATM33/e GPIOs	JP25 not installed
LEDs and Buttons are NOT powered and NOT connected to the ATM33/e GPIOs	JP27 not installed
SWD and UART signals are routed to the MK22N	JP11 not installed

Table 4 - ATM3330/e 7x7 mm Package v3.x EVB Default Configurations

3.3 ATM3330/e EVB v4.x Description

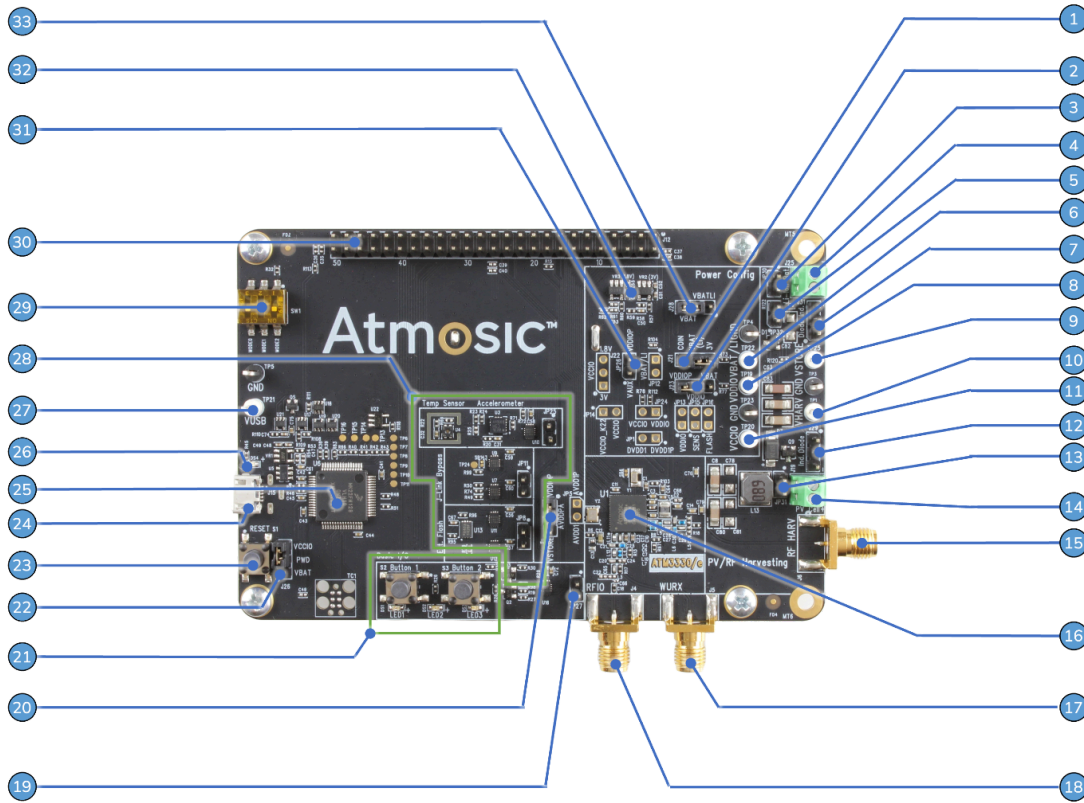

- | | |
|--|---------------------------------------|
| 1 - VBAT(LI) Source Select Jumper | 18 - Bluetooth LE RFIO Connector |
| 2 - VDDIO Select Jumper | 19 - LED/Button Enable Jumper |
| 3 - Bypass measurement resistor R122 | 20 - PA Supply Select Jumper |
| 4 - Li-Ion Battery Connector | 21 - General Purpose I/O |
| 5 - Inductive Charging Circuit Enable | 22 - Reset Voltage Select Jumper |
| 6 - VBAT(LI) Test Point (TP22) | 23 - Reset Button (S1) |
| 7 - Diode/Inductive Charging Select | 24 - Micro-B USB Connector |
| 8 - VDDIO Test Point (TP19) | 25 - EVB Management Processor (MK22N) |
| 9 - VSTORE Test Point (TP25) | 26 - USB Power LED |
| 10 - VHARV Test Point (TP1) | 27 - USB Power Test Point (TP21) |
| 11 - VCCIO Test Point (TP20) | 28 - Peripherals & Enable Jumpers |
| 12 - Diode/Inductive Charging Select | 29 - DIP Switches (3) |
| 13 - Inductive Charging Circuit Select | 30 - 50-Pin Expansion Header |
| 14 - PV Cell Connector | 31 - VDDIOP Disable |
| 15 - RF Harvester Input Connector | 32 - 1.8V/3.0V LDOs |
| 16 - ATM33/e | 33 - VBAT / VBATLI Select |
| 17 - Wake Up Receiver Connector | |

LED1: RED
 LED2: YELLOW
 LED3: BLUE

Push Button 1: (S2)
 Push Button 2: (S3)

Flash: JP8
 J-Link Bypass: JP11
 Sensors: JP25

Figure 5 - ATM3330/e 7x7 mm Package v4.x EVB Overview

Item	Component	Description
1	VBAT(LI) Source Select Jumper	<ul style="list-style-type: none"> • Select COIN if a coin cell battery is installed in the holder BT2 mounted on the back of the board and battery operation is desired. • Select 3 V if USB is connected and regulated 3.0 V operation (VBAT or VBATLI) is desired. • Select neither (no jumper) if an external supply (1.1 V - 3.3 V) is connected to TP22. <p>This option is used for power profiling of ATM3330/e or when a supply voltage other than 3.0 V for VBAT or VBATLI is desired.</p>
2	VDDIO Select Jumper	<ul style="list-style-type: none"> • Select VDDIOP if internally generated 1.8 V by the ATM3330/e is used for I/O voltage. <ul style="list-style-type: none"> ◦ Install <u>VCCIO Select Jumper</u> J22 (see below) accordingly. • Select VBAT if external VDDIO equal to VBAT is desired for I/O voltage. <ul style="list-style-type: none"> ◦ Install <u>VCCIO Select Jumper</u> J22 (see below) accordingly. ◦ Install <u>JP26</u> (to connect VDDIOP to VAUX) if VDDIOP is not used to power the PA (J3) for output power greater than 4dBm • Select neither (no jumper) if an external supply (1.8 V - 3.3 V) is connected to TP19. <ul style="list-style-type: none"> ◦ Install <u>JP26</u> (to connect VDDIOP to VAUX) if VDDIOP is not used to power the PA (J3) for output power greater than 4dBm
3	Bypass measurement resistor JP30	<ul style="list-style-type: none"> • Install JP30 to bypass measurement resistor R122 for real-world operation • Leave JP30 open to enable current-to-voltage conversion R122 for performance measurements
4	Li-Ion Battery Connector	<ul style="list-style-type: none"> • Connect a Li-Ion battery or Hybrid Supercapacitor to the board. Note that the polarity of the connector is marked in white silkscreen. • Insert the corresponding leads of the Li-Ion battery or Hybrid Supercapacitor into the connector and secure the leads by turning the screws clockwise until it's tight.
5	Inductive Charging Circuit Enable (JP32)	<ul style="list-style-type: none"> • Install JP32 when Inductive Charging Circuit is used. This will short VSTORE to GND to enable the operation of this charging circuit • Leave JP32 open when the Diode Charging Circuit is used
6	VBAT(LI) Test Point (TP22)	<ul style="list-style-type: none"> • Provide external VBAT or VBATLI voltage directly to the ATM3330/e, or • When an arbitrary VBAT voltage (different from 3 V) is desired. <p>Note: When TP22 is used, no jumper should be installed on J21.</p>
7	Diode/Inductive	<ul style="list-style-type: none"> • Select "Diode" (pins 1-2) for Diode Charging Circuit

Item	Component	Description
	Charging Select (J31)	<ul style="list-style-type: none"> Select “Ind.” (pins 2-3) for Inductive Charging Circuit
8	VDDIO Test Point (TP19)	<ul style="list-style-type: none"> Provide external VDDIO voltage directly to the ATM3330/e. <p>Note: When TP19 is used, no jumper should be installed on J23.</p>
9	VSTORE Test Point (TP25)	<ul style="list-style-type: none"> For monitoring the harvested energy level when PV or RF harvesting is enabled.
10	VHARV Test Point (TP1)	<ul style="list-style-type: none"> For connection to a digital multimeter (DMM) to monitor the output voltage of the ATM3330/e’s RF rectifier, or For connection to a photovoltaic (PV) cell or other energy harvesting devices as an input.
11	VCCIO Test Point (TP20)	<ul style="list-style-type: none"> Provide external VCCIO voltage for the peripheral devices on the board instead of using the on-board VDDIO-VCCIO auto-tracking circuit or the on-board 1.8V and 3.0V LDOs. Used when the VDDIO of the ATM3330/e is other than 1.8 V or 3 V and the VDDIO-VCCIO auto-tracking circuit is not used. This external VCCIO supply voltage needs to match the external VDDIO voltage on TP19. <p>Note: When TP20 is used, no jumper should be installed on J22 and resistor R113 should be removed.</p>
12	Diode/Inductive Charging Select (J29)	<ul style="list-style-type: none"> Select “Diode” (pins 1-2) for Diode Charging Circuit Select “Ind.” (pins 2-3) for Inductive Charging Circuit
13	Inductive Charging Circuit Select (JP31)	<ul style="list-style-type: none"> Install this Jumper JP31 to use the Inductive Charging Circuit Leave JP31 open if Diode Charging Circuit is used
14	PV Cell Connector	<ul style="list-style-type: none"> Connect a PV Cell to the board. Note that the polarity of the connector is marked in white silkscreen. Insert the corresponding leads of the PV Cell into the connector and secure the leads by turning the screws clockwise until it’s tight.
15	RF Harvester Input Connector	<ul style="list-style-type: none"> For connection to an antenna, or to an instrument for conducted measurements. The current matching components on the EVB are tuned for 915 MHz and can be modified to match to other frequencies such as 2400 MHz.
16	ATM3330e	<ul style="list-style-type: none"> 7x7 mm QFN 56-pin package with center GND pad

Item	Component	Description
17	Wake Up Receiver Connector	<ul style="list-style-type: none"> For connection to an antenna The current matching components on the EVB are tuned for 2400 MHz and can be modified to match to other frequencies such as 900 MHz.
18	Bluetooth LE RFIO Connector	<ul style="list-style-type: none"> For connection to a 2.4 GHz antenna, or An instrument (network analyzer, spectrum analyzer, Bluetooth LE tester)
19	LED/Button Enable Jumper	<ul style="list-style-type: none"> Install JP27 to enable functionality of the LEDs: <ul style="list-style-type: none"> LED1 : RED LED2 : YELLOW LED3 : BLUE Button 1 : S2 Button 2 : S3
20	PA Supply Select Jumper	<ul style="list-style-type: none"> Select nothing (no jumper) if Bluetooth LE transmit power is 4 dBm or lower. Select VDDIOP if Bluetooth LE transmit power is greater than 4 dBm and PV or RF harvesting is enabled (VSTORE is used for harvesting). Select VSTORE if Bluetooth LE transmit power is greater than 4 dBm and a PV or RF harvesting is <i>not</i> enabled (VSTORE is not used for harvesting). This mode allows the internal PA to be supplied by programmable variable VSTORE values (less than 1.8V) to improve the internal PA power efficiency.
21	General Purpose I/O	<ul style="list-style-type: none"> 2 Buttons and 3 LEDs controlled by GPIOs of ATM3330/e. <p>Note: JP25 needs to be installed to provide power to the 2 Buttons.</p>
22	Reset Voltage Select Jumper (J26)	<ul style="list-style-type: none"> Select VBAT if VCCIO is not available (USB is not connected) Select VCCIO if USB is connected and accurate power-down ATM3330/e current measurement is required.
23	Reset Button (S1)	<ul style="list-style-type: none"> To assert PWD to the ATM3330/e (pin 16) to reset the ATM3330/e.
24	Micro-B USB Connector	<ul style="list-style-type: none"> Provide power to the EVB and communication to the ATM3330/e.
25	EVB Management Processor (MK22N)	<ul style="list-style-type: none"> Used as a translation between USB, UART, and SWD.

Item	Component	Description
		<ul style="list-style-type: none"> ● Note: the main supply voltage level (VCCIO) of this processor needs to match that of the IO supply (VDDIO) of the ATM3330/e.
26	USB Power LED	<ul style="list-style-type: none"> ● Green LED lights up when the EVB is connected to a computer through the USB connector.
27	USB Power Test Point (TP21)	<ul style="list-style-type: none"> ● TP21 can be used to supply the board with an external 5 V in the case where a USB connection to the board is not available. <p>Note: TP21 should not be used concurrently with a USB connection to a host laptop.</p>
28	Peripheral & Enable Jumpers	<p>Enable for Flash (JP8), J-Link bypass (JP11), and Sensors (JP25)</p> <ul style="list-style-type: none"> ● Install JP8 to enable external Flash for EVBs with external Flash option. ● Install JP11 to disconnect the MK22N microcontroller I/O lines (SWD, UARTs) from the GPIOs of the ATM3330/e by switching the analog switches (U7, U9). <ul style="list-style-type: none"> ○ This option is useful for accurate power profiling of the ATM3330/e without interference from the MK22N. ● Install JP25 to enable the temperature sensor and accelerometer and power the General Purpose I/O. <ul style="list-style-type: none"> ○ ENS210 Temperature and Humidity Sensor ● Used by the demo application “HT_thermometer” or Sensor Beacon to demonstrate the ability of the ATM3330/e to retrieve temperature and humidity information from the sensor to facilitate software development. <ul style="list-style-type: none"> ○ LIS3DH Motion Sensor ● Used by demo application “lis2dh12_demo” to demonstrate the ability of the ATM3330/e to retrieve motion information from the sensor to facilitate software development.
29	DIP Switches (3)	<ul style="list-style-type: none"> ● For selecting different harvesting modes (Mode0, Mode1, Mode2) by pulling the GPIOs P11, P14, or P24 low through the resistor R32. ● If harvesting is not used, these switches can be ignored.
30	50-Pin Expansion Header	<ul style="list-style-type: none"> ● For connection to test instruments. ● All the GPIOs are by default available on this header.
31	VDDIOP Disable Jumper (JP26)	<ul style="list-style-type: none"> ● Install this Jumper JP26 when VDDIOP is not used to power VDDIO (J23) (see #7 above). <p>Note: Install only if VDDIOP is not used to power the PA (J3) for output</p>

Item	Component	Description
		<i>power greater than 4dBm</i>
32	1.8 V / 3.0 V LDOs	<ul style="list-style-type: none"> Supply voltages to the ATM3330e and other peripheral components using either 1.8 V or 3.0 V. These LDO's are powered by the USB power through the USB connector.
33	VBAT or VBATLI Select (J28)	<ul style="list-style-type: none"> Select VBAT (pins 2-3) to power the ATM3330e via the VBAT pin 20. Select VBATLI (pins 1-2) to power the ATM3330e via the VBATLI pin 28.

Table 5 - ATM3330/e 7x7 mm Package v4.x EVB Main Components Descriptions

In addition to the configurable jumpers described above, there are a few other jumpers on the board that are not installed by default because they are not normally needed for typical use. All these jumpers except one JP24 are shorted by default through solder bridges located immediately below them on the back side of the board. These jumpers can be seen in [Figure 6](#). See [Table 6](#) for descriptions of these jumpers.

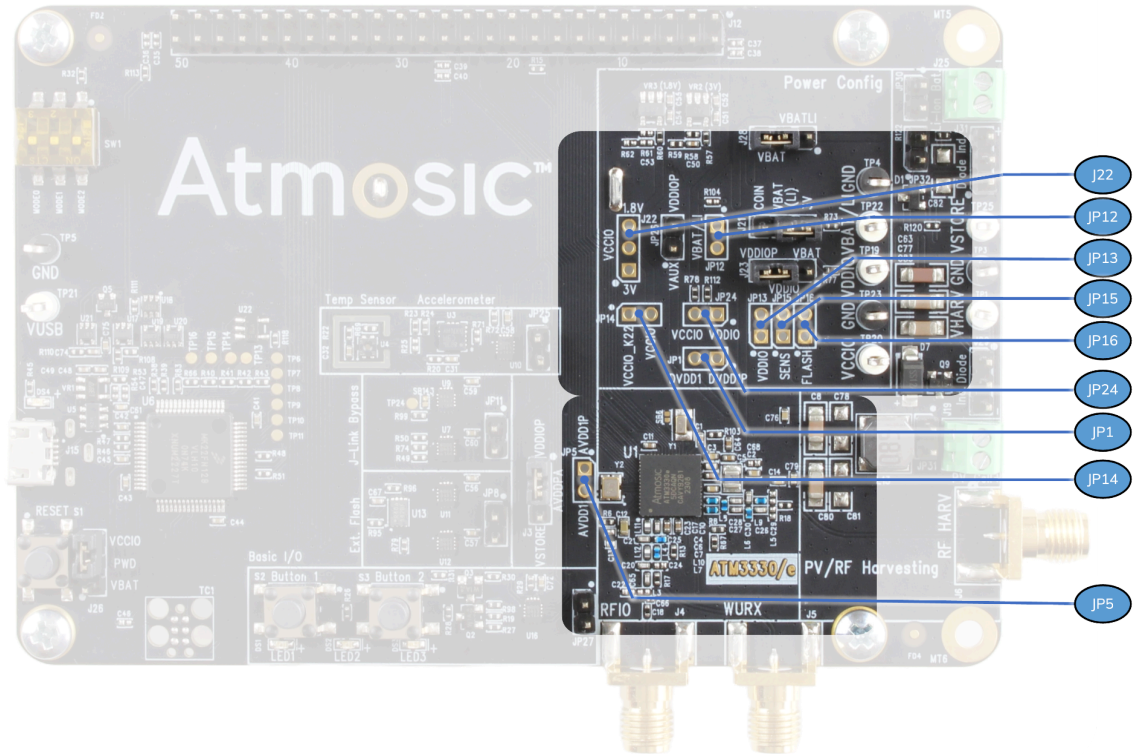

Figure 6 - ATM3330/e 7x7 mm Package v4.x EVB Jumper Locations

Jumper	Solder Bridge	Description
J22	N/A	<ul style="list-style-type: none"> This 3-pin header allows VCCIO to be connected to fixed 1.8V or 3.0V supplied by on-board LDOs, instead of allowing VCCIO to automatically track VDDIO by default through the on-board VDDIO-VCCIO auto-tracking circuit. Note: If this is used, resistor R113 needs to be removed to disengage the auto-tracking circuit.
JP12	SB136	<ul style="list-style-type: none"> In series with the net VBAT and is shorted by the solder bridge SB136 on the back side. SB136 can be cut to allow for current measurements on VBAT.
JP13	SB137	<ul style="list-style-type: none"> In series with the net VDDIO and is shorted by the solder bridge SB137 on the back side. SB137 can be cut to allow for current measurements on VDDIO.
JP15	SB140	<ul style="list-style-type: none"> In series with the net VDDIO_SENS and is shorted by the solder bridge

Jumper	Solder Bridge	Description
		<p>SB140 on the back side.</p> <ul style="list-style-type: none"> SB140 can be cut to allow for measurements of currents drawn by the sensors.
JP16	SB141	<ul style="list-style-type: none"> In series with the net VDDIO_FLASH and is shorted by the solder bridge SB141 on the back side. SB141 can be cut to allow for measurements of currents drawn by the external flash.
JP24	N/A	<ul style="list-style-type: none"> By default not installed and not shorted by a solder bridge. If installed, it would connect the peripheral supply VCCIO with the ATM3330e VDDIO supply, useful for the case where USB supply is not available.
JP1	SB2	<ul style="list-style-type: none"> In series with the net DVDD1 and is shorted by the solder bridge SB2 on the back side. SB2 can be cut to allow for current measurements on DVDD1.
JP14	SB138	<ul style="list-style-type: none"> In series with the net VCCIO_K22 and is shorted by the solder bridge SB138 on the back side. SB138 can be cut to allow for measurements of currents drawn by the MK22N processor.
JP5	SB9	<ul style="list-style-type: none"> In series with the net AVDD1 and is shorted by the solder bridge SB9 on the back side. SB9 can be cut to allow for current measurements on AVDD1.

Table 6 - ATM3330/e 7x7 mm Package v4.x EVB Jumpers Descriptions

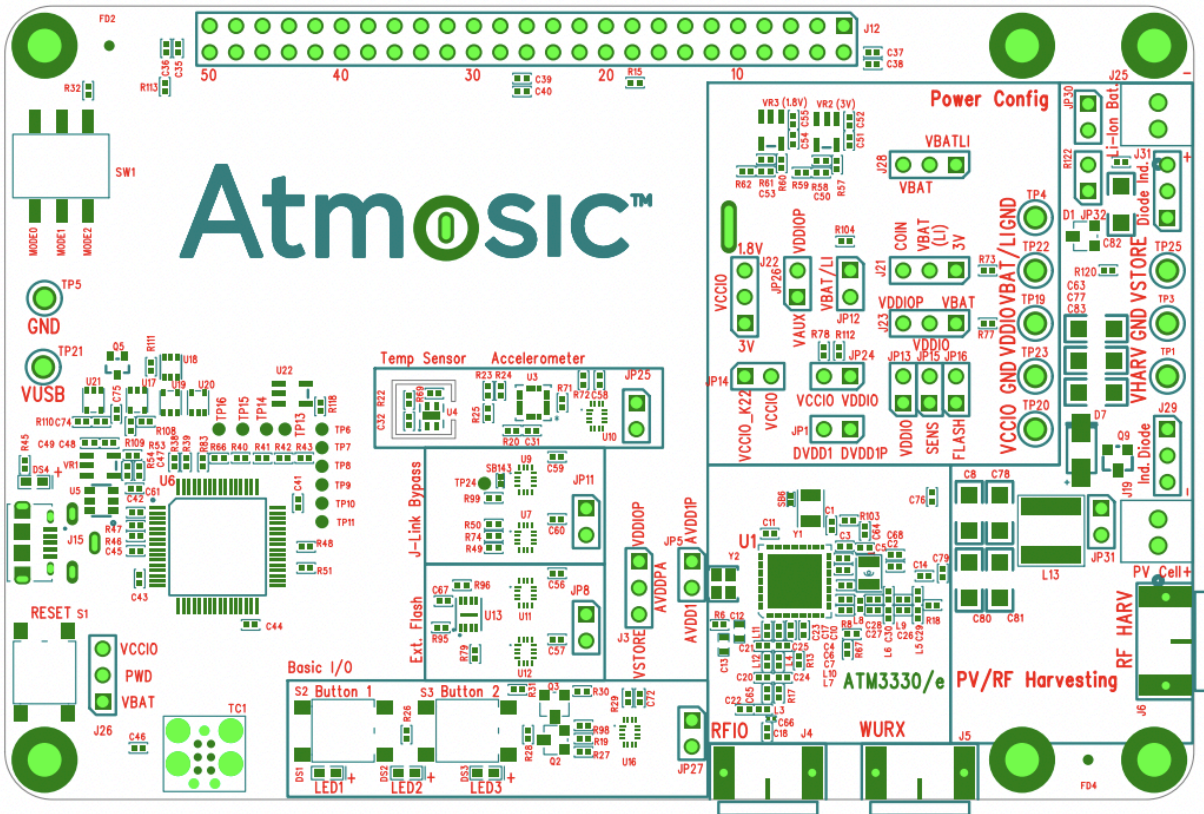

Figure 7 - ATM3330/e 7x7 mm Package v4.x EVB Top Silkscreen

The jumpers on the EVB have been configured for the following default mode of operation. See [Table 7](#).

Default Configuration	Jumper
The ATM3330e is powered through its VBAT pin 20	J28:2-3
The ATM3330e’s main supply VBAT comes from the coin cell battery	J21:2-3
The ATM3330e I/O voltage (VDDIO) is supplied by internally generated 1.8 V VDDIOP	J23:2-3
Peripheral supply VCCIO automatically tracks I/O voltage (VDDIO) of ATM3330e	J22 not installed
External flash is NOT powered and NOT connected to the ATM3300e GPIOs	JP8 not installed
Sensors are NOT powered and NOT connected to the ATM3300e GPIOs	JP25 not installed
LEDs and Buttons are NOT powered and NOT connected to the ATM3300e GPIOs	JP27 not installed
SWD and UART signals are routed to the MK22N	JP11 not installed

Table 7 - ATM3330/e 7x7 mm Package v4.x EVB Default Configurations

3.3.1 Boosting Circuit Configuration on ATM3330/e EVB v4.x

The ATM3330/e v4.x EVB supports three boost options of energy harvesting for different applications:

- Boost option 1: Inductive boost from VHARV
- Boost option 2: 2-diode boost from VSTORE
- Boost option 3: 2-diode boost from VHARV.

[Table 8](#) below shows the jumper configurations for each boost option. Note that JP30 should always be installed when charging a HSC, and is open only for measurements.

Boost	JP31	JP32	J29	J31	Jumper wire
Option 1	install	install	install 2-3	install 2-3	none
Option 2	open	open	install 1-2	install 1-2	none
Option 3	open	open	install 1-2	install 1-2	connect JP31.1 to JP32.1

Table 8 - ATM3330e v4.x EVB Boosting Options Jumper Configurations

3.4 ATM3325 EVB Description

[Figure 8](#) highlights some of the key components of the ATM3325 EVB. [Table 9](#) provides the descriptions of the labeled components.

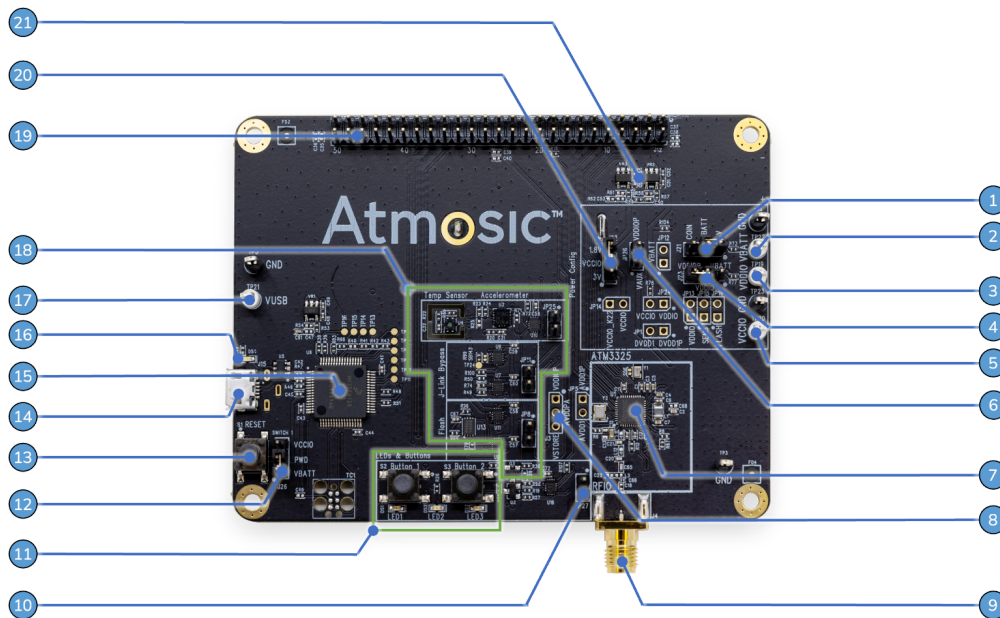

- | | | |
|---------------------------------------|-----------------------------------|--|
| 1 - VBAT Select Jumper | 16 - USB Power LED | |
| 2 - VBAT Test Point (TP22) | 17 - USB Power Test Point (TP21) | |
| 3 - VDDIO Test Point (TP19) | 18 - Peripherals & Enable Jumpers | |
| 4 - VDDIO Select Jumper | 19 - 50-Pin Expansion Header | |
| 5 - VCCIO Test Point (TP20) | 20 - VCCIO Select Jumper | |
| 6 - VDDIOP Disable Jumper | 21 - 1.8V/3.0V LDOs | |
| 7 - ATM3325 | | |
| 8 - PA Supply Select Jumper | | |
| 9 - Bluetooth LE RFIO Connector | | |
| 10 - LED/Button Enable Jumper | | |
| 11 - General Purpose I/O | | |
| 12 - Reset Voltage Select Jumper | | |
| 13 - Reset Button (S1) | | |
| 14 - Micro-B USB Connector | | |
| 15 - EVB Management Processor (MK22N) | | |
- Flash: JP8
 J-Link Bypass: JP11
 Sensors: JP25
- LED1: RED
 LED2: YELLOW
 LED3: BLUE

Push Button 1: (S2)
 Push Button 2: (S3)

Figure 8 - ATM3325 5x5 mm Package v3.x EVB Overview

Item	Component	Description
1	VBAT Select Jumper	<ul style="list-style-type: none"> J21 is used to connect VBAT of the ATM3325 to either the 3.0V

Item	Component	Description
		<p>produced by the on-board LDO or the coin cell battery in the holder (BT2) mounted on the back of the board.</p> <ul style="list-style-type: none"> For power profiling of ATM3325, VBAT can also be sourced externally by a power supply at any voltage (1.1 V - 3.3 V) through TP22, without any jumpers installed on J21.
2	VBAT Test Point (TP22)	<ul style="list-style-type: none"> Provide external VBAT voltage directly to the ATM3325 (not using the LDO's), or When an arbitrary VBAT voltage (different from 3 V) is desired. <p>Note: When TP22 is used, no jumper should be installed on J21.</p>
3	VDDIO Test Point (TP19)	<ul style="list-style-type: none"> TP19 is used to provide external VDDIO voltage directly to the ATM3325's I/O (not using the LDO's). This is used for power profiling or when a VDDIO voltage other than 1.8 V or VBAT is desired for the I/O supply of the ATM3325. <p>Note: when TP19 is used, no jumper should be installed on J23.</p>
4	VDDIO Select Jumper	<ul style="list-style-type: none"> J23 is used to connect VDDIO of the ATM3325 to either VDDIOP (internally generated 1.8 V by the ATM3325) or VBAT. J22 and J23 need to be set such that VCCIO = VDDIO. For example, if VDDIO is connected to VDDIOP (using internally generated 1.8 V) then VCCIO should be connected to 1.8 V. If VDDIO is connected to VBAT and VBAT is connected to 3.0 V, then VCCIO should be connected to 3 V. If VDDIO is neither 1.8 V nor 3 V, then VCCIO should be connected to an external power supply through TP20 set to the same voltage as VDDIO.
5	VCCIO Test Point (TP20)	<ul style="list-style-type: none"> Provide external VCCIO voltage for the peripheral devices on the board, not using the LDO's. Used when the VDDIO of the ATM3325 is other than 1.8 V or 3 V because VCCIO voltage has to match VDDIO voltage. <p>Note: When TP20 is used, no jumper should be installed on J22.</p>
6	VDDIOP Disable Jumper	<ul style="list-style-type: none"> Install this Jumper JP26 when VDDIOP is not used to power VDDIO (J23) (see #4 above). <p>Note: Install only if VDDIOP is not used to power the PA (J3) for output power greater than 4dBm</p>

Item	Component	Description
7	ATM3325	5x5 mm QFN 40-pin package with center GND pad.
8	PA Supply Select Jumper	<ul style="list-style-type: none"> ● J3 allows the option of supplying the internal ATM3325 Power Amplifier with either VDDIOP (1.8 V) or VSTORE voltage. ● This jumper J3 applies only when the transmit power is greater than 4 dBm. ● For transmit power 4 dBm and below, the Power Amplifier uses internally supplied 1 V core voltage by default.
9	Bluetooth LE RFIO Connector	<ul style="list-style-type: none"> ● For connection to a 2.4 GHz antenna, or ● An instrument for conducted measurements.
10	LED/Button Enable Jumper	<ul style="list-style-type: none"> ● Install JP27 to enable the three LEDs (LED1, LED2, LED3) and Button 2. <ul style="list-style-type: none"> ○ When JP27 is installed, the control signals for the LEDs and Button 2 are connected to GPIOs of the ATM3325 through analog switches (U16). ○ When JP27 is open these control signals are disconnected, but there may be leakage currents of up to 5 nA per connection from the analog switches at room temperature. <p><i>Note: LED2 and LED3 are powered from the 3.3 V LDO, whereas LED1 is powered by the control signal itself.</i></p> <p><i>Note: Button 1 and Button 2 are powered by sensor supply and therefore require JP25 to be also installed for the sensor supply to be connected to VDDIO.</i></p>
11	General Purpose I/O	<ul style="list-style-type: none"> ● Install JP27 to enable functionality of the LEDs: <ul style="list-style-type: none"> ○ LED1 : RED, driven directly by P29 ○ LED2 : YELLOW, driven by P4 through a NPN transistor. ○ LED3 : BLUE, not driven by any GPIO but through a NPN transistor. However, there is TP25 nearby, which can be used to input the control signal for LED3. ● Install also JP27 to enable <ul style="list-style-type: none"> ○ Button 1 : S2 ○ Button 2 : S3
12	Reset Voltage Select Jumper	<ul style="list-style-type: none"> ● J26 is used to select whether the PWD signal used to reset the ATM3325 is sourced by VBAT or VCCIO. ● The option to use VCCIO is useful for accurate current measurements of the ATM3325 since the PWD signal current will be drawn from VCCIO, which is a separate domain from VBAT.

Item	Component	Description
13	Reset Button (S1)	<ul style="list-style-type: none"> To assert PWD to the ARM3325 (pin 12) to reset the ATM3325. This pin is pulled low by default through the resistor R8 (1M Ω). When the button is pressed, it gets pulled high to VBAT or VCCIO (see description under Reset Voltage Select Jumper above) and thus resets the ATM3325.
14	Micro-B USB Connector	<ul style="list-style-type: none"> Provide power to the EVB as well as communication to the ATM3325. The 5 V from the USB powers the three Low-Drop-Out regulators to generate 3.3 V for the MK22N processor USB block and 3.0 V and 1.8 V options for the ATM3325.
15	EVB Management Processor (MK22N)	<ul style="list-style-type: none"> Used as a translation between USB and UART and SWD. <p><i>Note: the main supply voltage level of this processor needs to match that of the I/O supply of the ATM3325.</i></p>
16	USB Power LED	<ul style="list-style-type: none"> Green LED lights up when the EVB is connected to a computer through the USB connector.
17	USB Power Test Point (TP21)	<ul style="list-style-type: none"> TP21 can be used to supply the board with an external 5 V in the case where a USB connection to the board is not available. This external 5 V will power the LDO's and enable the board to function without a host laptop, provided the ATM3325 has already been programmed and communication with a host laptop is not required. <p><i>Note: TP21 should not be used concurrently with a USB connection to a host laptop.</i></p>
18	Peripheral & Enable Jumpers	<p>Enable for Flash (JP8), J-Link bypass (JP11), and Sensors (JP25)</p> <ul style="list-style-type: none"> Install JP8 to enable external Flash. <ul style="list-style-type: none"> When JP8 is installed, the supply of the flash is connected to VDDIO, and I/Os of the flash are connected to the GPIOs of the ATM3325 through analog switches (U11, U12). When JP8 is open, the flash supply and I/Os are disconnected, but there may be leakage currents of up to 5 nA per connection from the analog switches at room temperature. Install JP11 to disconnect the MK22N microcontroller I/O lines (SWD, UARTs) from the GPIOs of the ATM3325 by the analog switches (U7, U9).

Item	Component	Description
		<ul style="list-style-type: none"> ○ This option is useful for accurate power profiling of the ATM3325 without interference from the MK22N. ● Install JP25 to enable the temperature sensor and accelerometer. <ul style="list-style-type: none"> ○ When JP25 is installed, the supply of these two sensors are connected to VDDIO, and the I/Os of the sensors are connected to GPIOs of the ATM3325 through the analog switches (U10). ○ When JP25 is open, the sensor supply and I/Os are disconnected, but there may be leakage currents of up to 5 nA per connection from the analog switches at room temperature. ● ENS210 Temperature and Humidity Sensor <ul style="list-style-type: none"> ○ Used by the demo application including HT_thermometer or Sensor Beacon. ● LIS3DH Motion Sensor <ul style="list-style-type: none"> ○ Used by the demo application including HT_thermometer or Sensor Beacon.
19	50-Pin Expansion Header	<ul style="list-style-type: none"> ● For connection to test instruments. ● All the GPIOs are by default available on this header.
20	VCCIO Select Jumper	<ul style="list-style-type: none"> ● J22 is used to connect VCCIO, which is the supply and I/O rails of the peripheral devices such as flash, sensors, and MK22N processor, to either 1.8 V or 3.0 V. ● J22 and J23 need to be set such that VCCIO = VDDIO. ● For example, if VDDIO is connected to VDDIOP (using internally generated 1.8 V) then VCCIO should be connected to 1.8 V. ● If VDDIO is connected to VBAT and VBAT is connected to 3.0 V, then VCCIO should be connected to 3 V. ● If VDDIO is neither 1.8 V nor 3 V, then VCCIO should be connected to an external power supply through TP20 set to the same voltage as VDDIO.
21	1.8 V / 3.0 V LDOs	<ul style="list-style-type: none"> ● Supply voltages to the ATM3325 and other peripheral components using either 1.8 V or 3.0 V. ● These LDO's are powered by the USB power through the USB connector.

Table 9 - ATM3325 5x5 mm Package v3.x EVB Main Components Descriptions

In addition to the configurable jumpers described above, there are a few other jumpers on the board that are not installed by default because they are normally not needed for typical use.

All these jumpers except JP24 are shorted by default through solder bridges located immediately below them on the back side of the board.

These jumpers can be seen highlighted in green in [Figure 9](#). See [Table 10](#) for descriptions of these jumpers.

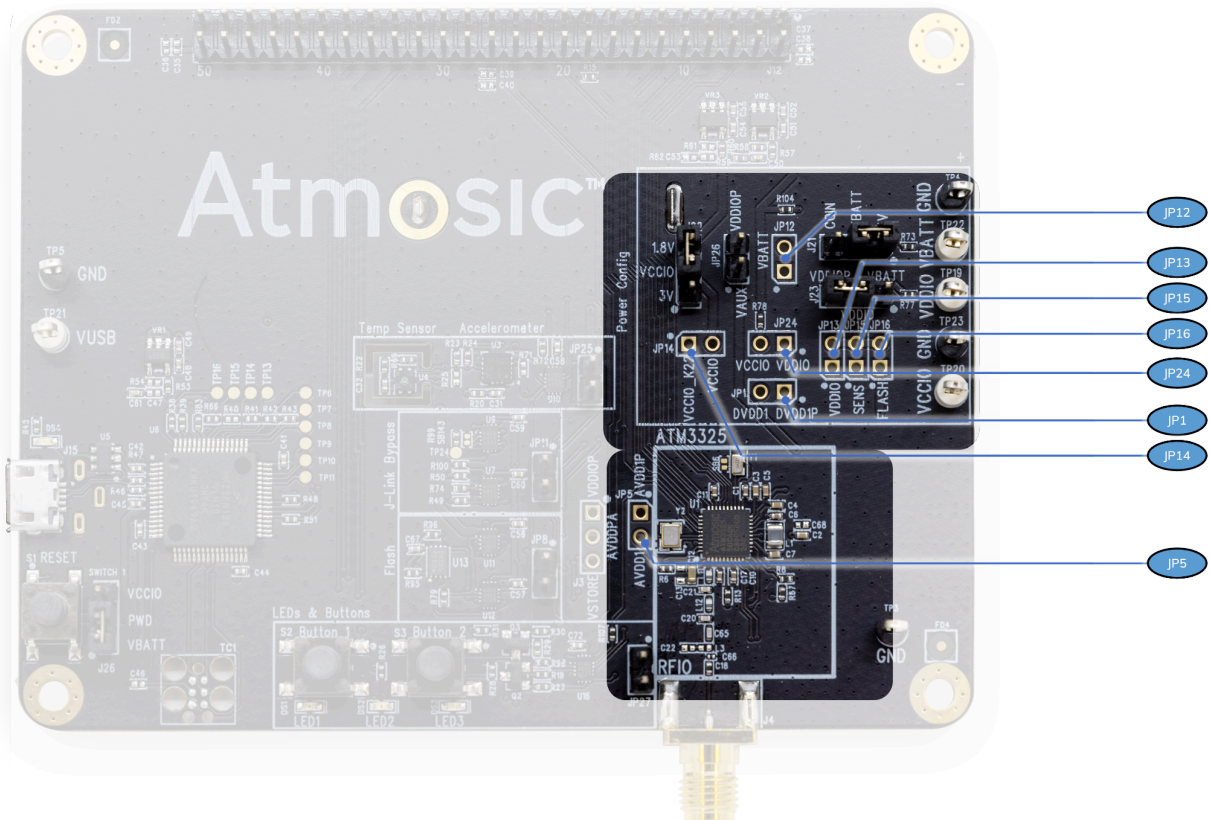

Figure 9 - ATM3325 5x5 mm Package v3.x EVB Jumper Locations

Jumper	Solder Bridge	Description
JP12	SB136	<ul style="list-style-type: none"> In series with the net <i>VBAT</i> and is shorted by the solder bridge SB136 on the back side. SB136 can be cut to allow for current measurements on <i>VBAT</i>.
JP13	SB137	<ul style="list-style-type: none"> In series with the net <i>VDDIO</i> and is shorted by the solder bridge SB137 on the back side.

Jumper	Solder Bridge	Description
		<ul style="list-style-type: none"> SB137 can be cut to allow for current measurements on VDDIO.
JP15	SB140	<ul style="list-style-type: none"> In series with the net VDDIO_SENS and is shorted by the solder bridge SB140 on the back side. SB140 can be cut to allow for measurements of currents drawn by the sensors.
JP16	SB141	<ul style="list-style-type: none"> In series with the net VDDIO_FLASH and is shorted by the solder bridge SB141 on the back side. SB141 can be cut to allow for measurements of currents drawn by the external flash.
JP24	N/A	<ul style="list-style-type: none"> By default not installed and not shorted by a solder bridge. If installed, it would connect the peripheral supply VCCIO with the ATM3325 VDDIO supply, useful for the case where USB supply is not available.
JP1	SB2	<ul style="list-style-type: none"> In series with the net DVDD1 and is shorted by the solder bridge SB2 on the back side. SB2 can be cut to allow for current measurements on DVDD1.
JP14	SB138	<ul style="list-style-type: none"> In series with the net VCCIO_K22 and is shorted by the solder bridge SB138 on the back side. SB138 can be cut to allow for measurements of currents drawn by the MK22N processor.
JP5	SB9	<ul style="list-style-type: none"> In series with the net AVDD1 and is shorted by the solder bridge SB9 on the back side. SB9 can be cut to allow for current measurements on AVDD1.

Table 10 - ATM3325 5x5 mm Package v3.x EVB Jumpers Descriptions

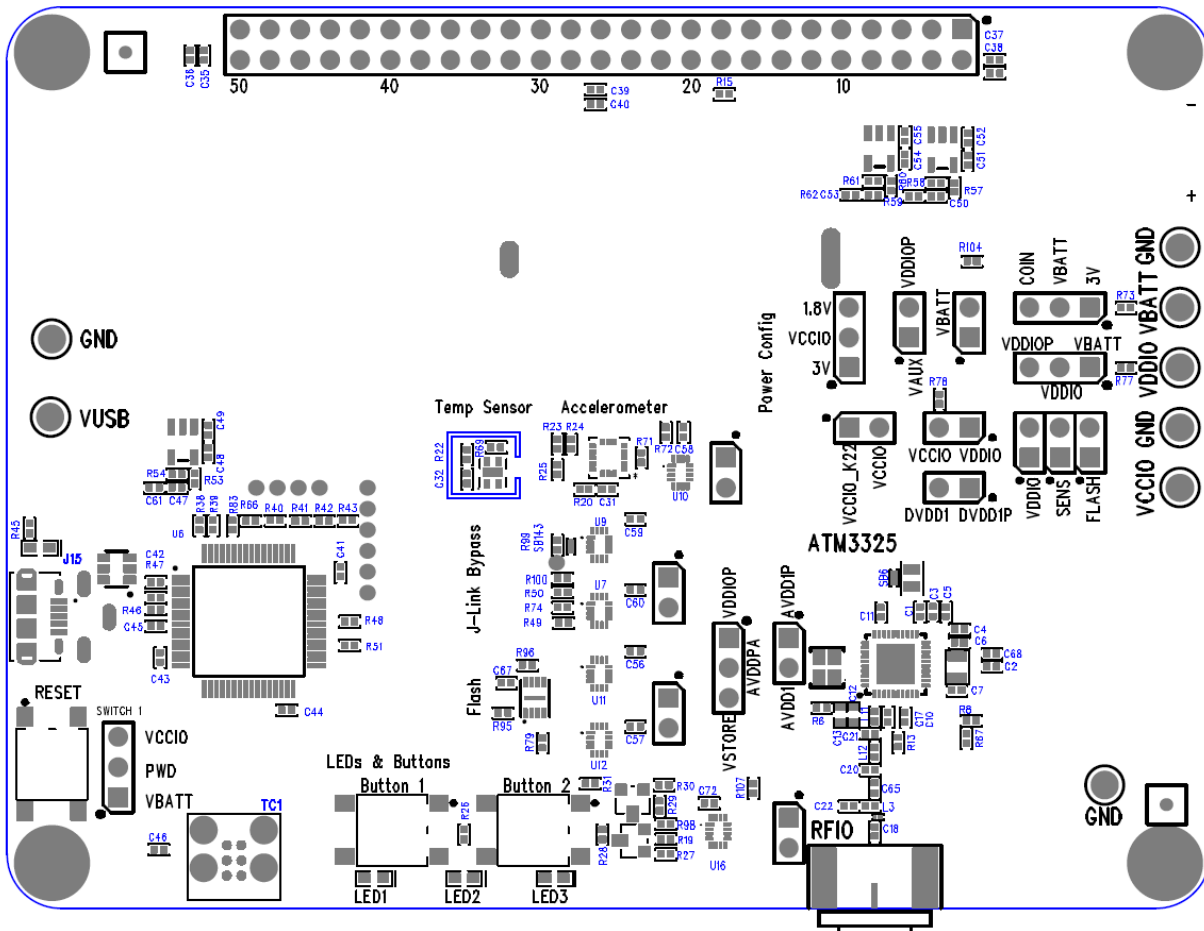

Figure 10 - ATM3325 5x5 mm Package v3.x EVB Top Silkscreen

The jumpers on the EVB have been configured for the following default mode of operation. See [Table 11](#).

Default Configuration	Jumper
The ATM3325's main supply VBAT comes from the coin cell battery	J21
The ATM3325 uses internal IO voltage supplied by 1.8 V VDDIOP	J23
Peripheral supply VCCIO is connected to 1.8 V LDO	J22
External flash is NOT powered and NOT connected to the ATM3325 GPIOs	JP8 not installed
Sensors are NOT powered and NOT connected to the ATM3325 GPIOs	JP25 not installed
LEDs and Buttons are NOT powered and NOT connected to the ATM3325 GPIOs	JP27 not installed
SWD and UART signals are routed to the MK22N	JP11 not installed

Table 11 - ATM3325 5x5 mm Package v3.x EVB Default Configurations

3.5 ATM3325 with Extended Storage EVB Description

Figure 11 highlights some of the key components of the ATM3325 with extended storage EVB. Table 12 provides the descriptions of the labeled components.

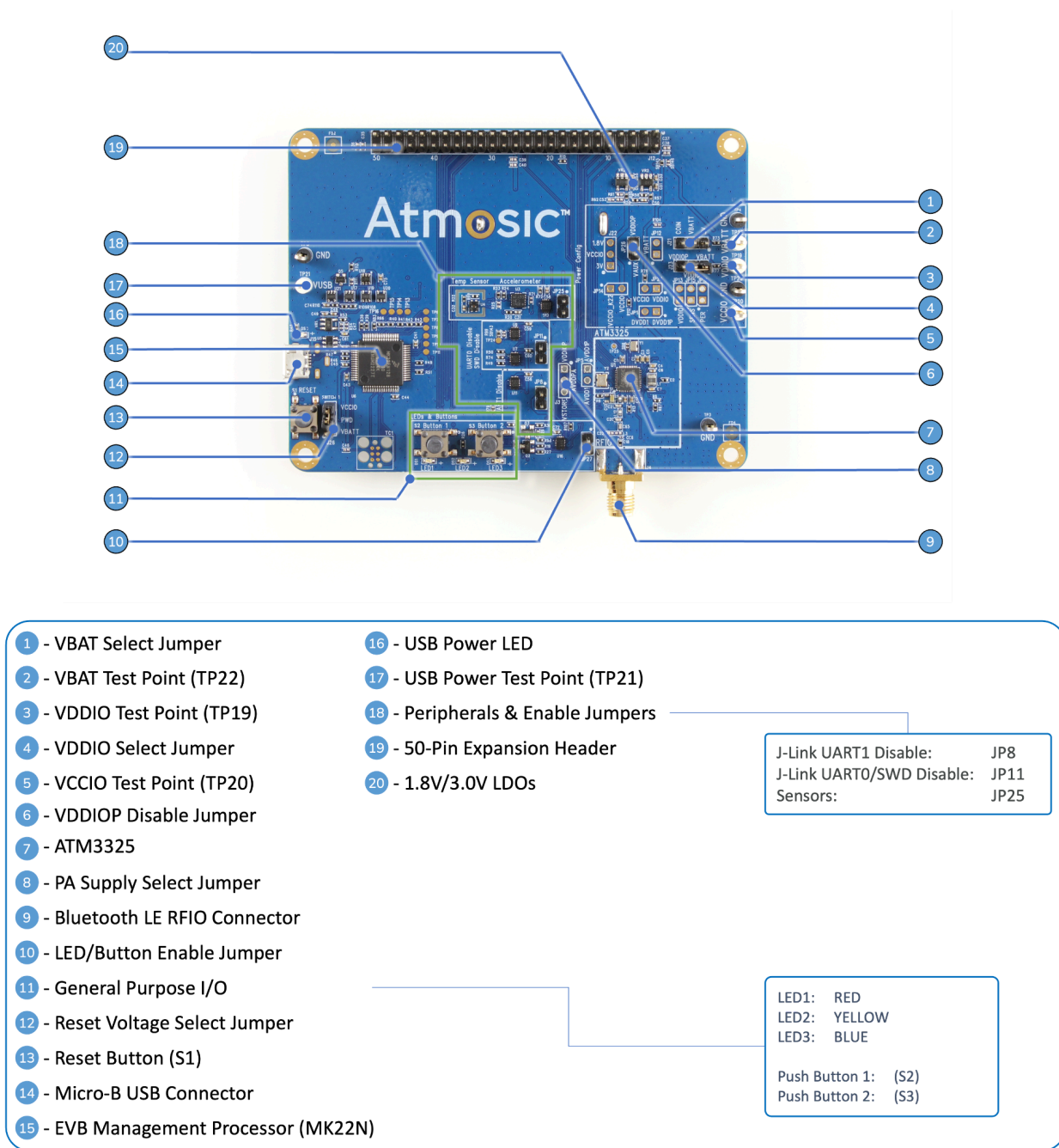

Figure 11 - ATM3325 with Extended Storage 5x5 mm Package v3.x EVB Overview

Item	Component	Description
1	VBAT Select Jumper	<ul style="list-style-type: none"> J21 is used to connect VBAT of the ATM3325 to either the 3.0 V produced by the on-board LDO or the coin cell battery in the holder (BT2) mounted on the back of the board. For power profiling of ATM3325, VBAT can also be sourced externally by a power supply at any voltage (1.1 V - 3.3 V) through TP22, without any jumpers installed on J21.
2	VBAT Test Point (TP22)	<ul style="list-style-type: none"> Provide external VBAT voltage directly to the ATM3325 (not using the LDO's), or When an arbitrary VBAT voltage (different from 3 V) is desired. <p><i>Note: When TP22 is used, no jumper should be installed on J21.</i></p>
3	VDDIO Test Point (TP19)	<ul style="list-style-type: none"> TP19 is used to provide external VDDIO voltage directly to the ATM3325's I/O (not using the LDO's). This is used for power profiling or when a VDDIO voltage other than 1.8 V or VBAT is desired for the I/O supply of the ATM3325. <p><i>Note: when TP19 is used, no jumper should be installed on J23.</i></p>
4	VDDIO Select Jumper	<ul style="list-style-type: none"> J23 is used to connect VDDIO of the ATM3325 to either VDDIOP (internally generated 1.8 V by the ATM3325) or VBAT. J22 and J23 need to be set such that VCCIO = VDDIO. For example, if VDDIO is connected to VDDIOP (using internally generated 1.8 V) then VCCIO should be connected to 1.8 V. If VDDIO is connected to VBAT and VBAT is connected to 3.0 V, then VCCIO should be connected to 3 V. If VDDIO is neither 1.8 V nor 3 V, then VCCIO should be connected to an external power supply through TP20 set to the same voltage as VDDIO.
5	VCCIO Test Point (TP20)	<ul style="list-style-type: none"> Provide external VCCIO voltage for the peripheral devices on the board, not using the LDO's. Used when the VDDIO of the ATM3325 is other than 1.8 V or 3 V because VCCIO voltage has to match VDDIO voltage. <p><i>Note: When TP20 is used, no jumper should be installed on J22.</i></p>
6	VDDIOP Disable Jumper	<ul style="list-style-type: none"> Install this Jumper JP26 when VDDIOP is not used to power VDDIO (J23) (see #4 above). <p><i>Note: Install only if VDDIOP is not used to power the PA (J3) for output</i></p>

Item	Component	Description
		<i>power greater than 4dBm</i>
7	ATM3325	5x5 mm QFN 40-pin package with center GND pad.
8	PA Supply Select Jumper	<ul style="list-style-type: none"> ● J3 allows the option of supplying the internal ATM3325 Power Amplifier with either VDDIOP (1.8 V) or VSTORE voltage. ● By default, J3 is not installed, and the ATM3325 Power Amplifier supply is connected to VDDIOP through a solder bridge (SB144) located below J3 on the back side of the board. ● This jumper J3 applies only when the transmit power is greater than 4 dBm. ● For transmit power 4 dBm and below, the Power Amplifier uses internally supplied 1 V core voltage by default.
9	Bluetooth LE RFIO Connector	<ul style="list-style-type: none"> ● For connection to a 2.4 GHz antenna, or ● An instrument for conducted measurements.
10	LED/Button Enable Jumper	<ul style="list-style-type: none"> ● Install JP27 to enable the three LEDs (LED1, LED2, LED3) and Button 2. <ul style="list-style-type: none"> ○ When JP27 is installed, the control signals for the LEDs and Button 2 are connected to GPIOs of the ATM3325 through analog switches (U16). ○ When JP27 is open these control signals are disconnected, but there may be leakage currents of up to 5 nA per connection from the analog switches at room temperature. <p><i>Note: LED2 and LED3 are powered from the 3.3 V LDO, whereas LED1 is powered by the control signal itself.</i></p> <p><i>Note: Button 1 and Button 2 are powered by sensor supply and therefore require JP25 to be also installed for the sensor supply to be connected to VDDIO.</i></p>
11	General Purpose I/O	<ul style="list-style-type: none"> ● Install JP27 to enable functionality of the LEDs: <ul style="list-style-type: none"> ○ LED1 : RED, driven directly by P29 ○ LED2 : YELLOW, driven by P4 through a NPN transistor. ○ LED3 : BLUE, not driven by any GPIO but through a NPN transistor. However, there is TP25 nearby, which can be used to input the control signal for LED3. ● Install also JP27 to enable <ul style="list-style-type: none"> ○ Button 1 : S2 ○ Button 2 : S3

Item	Component	Description
12	Reset Voltage Select Jumper	<ul style="list-style-type: none"> J26 is used to select whether the PWD signal used to reset the ATM3325 is sourced by VBAT or VCCIO. The option to use VCCIO is useful for accurate current measurements of the ATM3325 since the PWD signal current will be drawn from VCCIO, which is a separate domain from VBAT.
13	Reset Button (S1)	<ul style="list-style-type: none"> To assert PWD to the ARM3325 (pin 12) to reset the ATM3325. This pin is pulled low by default through the resistor R8 (1M Ω). When the button is pressed, it gets pulled high to VBAT or VCCIO (see description under Reset Voltage Select Jumper above) and thus resets the ATM3325.
14	Micro-B USB Connector	<ul style="list-style-type: none"> Provide power to the EVB as well as communication to the ATM3325. The 5 V from the USB powers the three Low-Drop-Out regulators to generate 3.3 V for the MK22N processor USB block and 3.0 V and 1.8 V options for the ATM3325.
15	EVB Management Processor (MK22N)	<ul style="list-style-type: none"> Used as a translation between USB and UART and SWD. <p><i>Note: the main supply voltage level of this processor needs to match that of the I/O supply of the ATM3325.</i></p>
16	USB Power LED	<ul style="list-style-type: none"> Green LED lights up when the EVB is connected to a computer through the USB connector.
17	USB Power Test Point (TP21)	<ul style="list-style-type: none"> TP21 can be used to supply the board with an external 5 V in the case where a USB connection to the board is not available. This external 5 V will power the LDO's and enable the board to function without a host laptop, provided the ATM3325 has already been programmed and communication with a host laptop is not required. <p><i>Note: TP21 should not be used concurrently with a USB connection to a host laptop.</i></p>
18	Peripheral & Enable Jumpers	<p>J-Link UART1 Disable (JP8), J-Link UART0/SWD Disable (JP11), and Sensors (JP25)</p> <ul style="list-style-type: none"> Install JP8 to disconnect the ATM3325's UART1 lines from to the MK22N microcontroller. <ul style="list-style-type: none"> When JP8 is open, the MK22N UART1 lines are connected to the ATM3325 UART1 lines to allow communication between the ATM3325 and the host computer. The ATM3325's P21 and P27 will

Item	Component	Description
		<p>source/sink some current.</p> <ul style="list-style-type: none"> ○ When JP8 is installed, the ATM3325 UART1 lines are disconnected from the MK22N UART1 lines, but there may be leakage currents of up to 5 nA per connection from the analog switches at room temperature. This option is useful for accurate power profiling of the ATM3325 without interference from the MK22N. <ul style="list-style-type: none"> ● Install JP11 to disconnect the MK22N microcontroller I/O lines (UART0, SWD) from the UART0 and SWD lines of the ATM3325 by the analog switches (U7, U9). <ul style="list-style-type: none"> ○ When JP11 is open, the MK22N UART0 and SWD lines are connected to the ATM3325 UART0 and SWD lines to allow communication between the ATM3325 and the host computer. The ATM3325's P0, P1, P25, P17, P19, P20, and P30 will source/sink some current. ○ When JP11 is installed, the ATM3325 UART0 and SWD lines are disconnected from the MK22N UART0 and SWD lines, but there may be leakage currents of up to 5 nA per connection from the analog switches at room temperature. This option is useful for accurate power profiling of the ATM3325 without interference from the MK22N. ● Install JP25 to enable the temperature sensor and accelerometer. <ul style="list-style-type: none"> ○ When JP25 is installed, the supply of these two sensors are connected to VDDIO, and the I/Os of the sensors are connected to GPIOs of the ATM3325 through the analog switches (U10). ○ When JP25 is open, the sensor supply and I/Os are disconnected, but there may be leakage currents of up to 5 nA per connection from the analog switches at room temperature. ● ENS210 Temperature and Humidity Sensor <ul style="list-style-type: none"> ○ Used by the demo application including HT_thermometer or Sensor Beacon. ● LIS3DH Motion Sensor <ul style="list-style-type: none"> ○ Used by the demo application including HT_thermometer or Sensor Beacon.

Item	Component	Description
19	50-Pin Expansion Header	<ul style="list-style-type: none"> • For connection to test instruments. • All the GPIOs are by default available on this header.
20	1.8 V / 3.0 V LDOs	<ul style="list-style-type: none"> • Supply voltages to the ATM3325 and other peripheral components using either 1.8 V or 3.0 V. • These LDO's are powered by the USB power through the USB connector.

Table 12 - ATM3325 with Extended Storage 5x5 mm Package v3.x EVB Main Components Descriptions

In addition to the configurable jumpers described above, there are a few other jumpers on the board that are not installed by default because they are normally not needed for typical use.

All these jumpers except J22 and JP24 are shorted by default through solder bridges located immediately below them on the back side of the board.

These jumpers can be seen highlighted in green in [Figure 12](#). See [Table 13](#) for descriptions of these jumpers.

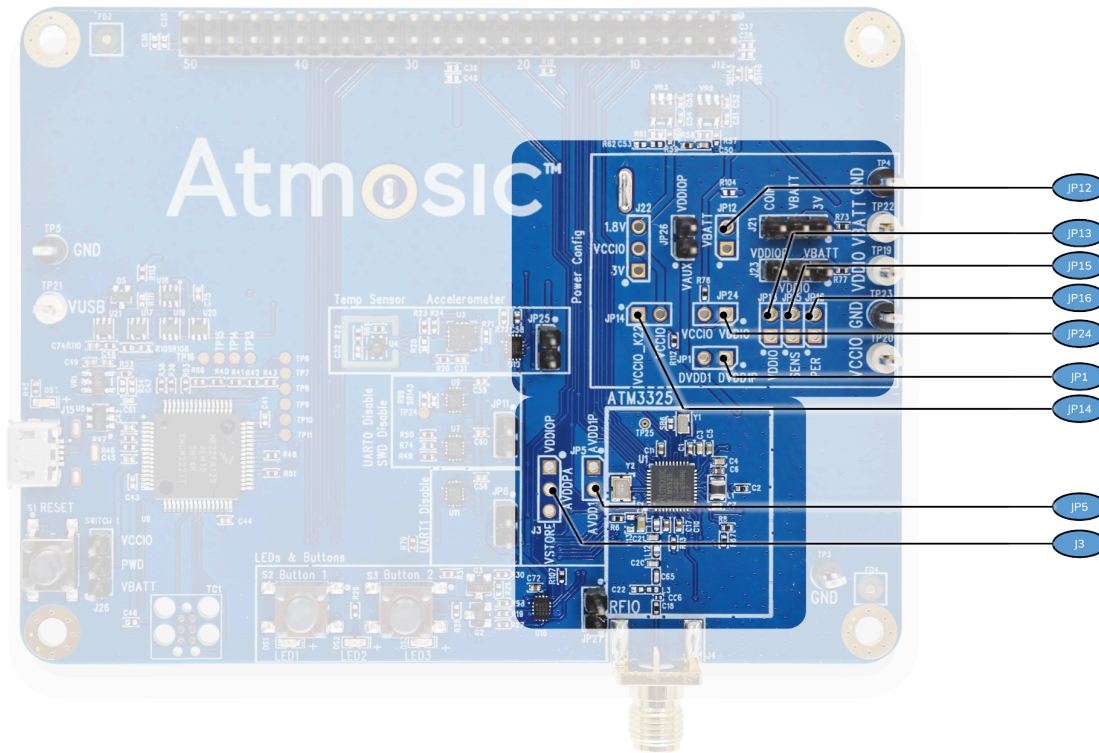

Figure 12 - ATM3325 with Extended Storage 5x5 mm Package v3.x EVB Jumper Locations

Jumper	Solder Bridge	Description
JP12	SB136	<ul style="list-style-type: none"> In series with the net VBAT and is shorted by the solder bridge SB136 on the back side. SB136 can be cut to allow for current measurements on VBAT.
JP13	SB137	<ul style="list-style-type: none"> In series with the net VDDIO and is shorted by the solder bridge SB137 on the back side. SB137 can be cut to allow for current measurements on VDDIO.
JP15	SB140	<ul style="list-style-type: none"> In series with the net VDDIO_SENS and is shorted by the solder bridge SB140 on the back side. SB140 can be cut to allow for measurements of currents drawn by the sensors.

Jumper	Solder Bridge	Description
JP16	SB141	<ul style="list-style-type: none"> In series with the net VDDIO_FLASH and is shorted by the solder bridge SB141 on the back side. SB141 can be cut to allow for measurements of currents drawn by the external flash.
JP24	N/A	<ul style="list-style-type: none"> By default not installed and not shorted by a solder bridge. If installed, it would connect the peripheral supply VCCIO with the ATM3325 VDDIO supply, useful for the case where USB supply is not available.
JP1	SB2	<ul style="list-style-type: none"> In series with the net DVDD1 and is shorted by the solder bridge SB2 on the back side. SB2 can be cut to allow for current measurements on DVDD1.
JP14	SB138	<ul style="list-style-type: none"> In series with the net VCCIO_K22 and is shorted by the solder bridge SB138 on the back side. SB138 can be cut to allow for measurements of currents drawn by the MK22N processor.
JP5	SB9	<ul style="list-style-type: none"> In series with the net AVDD1 and is shorted by the solder bridge SB9 on the back side. SB9 can be cut to allow for current measurements on AVDD1.
JP3	SB144	<ul style="list-style-type: none"> J3 allows the option of supplying the internal ATM3325 Power Amplifier with either VDDIOP (1.8 V) or VSTORE voltage. By default, J3 is not installed, and the ATM3325 Power Amplifier supply is connected to VDDIOP through a solder bridge (SB144) located below J3 on the back side of the board. This jumper J3 applies only when the transmit power is greater than 4 dBm. For transmit power 4 dBm and below, the Power Amplifier uses internally supplied 1 V core voltage by default.

Table 13 - ATM3325 with Extended Storage 5x5 mm Package v3.x EVB Jumpers Descriptions

3.6 ATM3325 WLCSP EVB Description

Figure 14 highlights some of the key components of the ATM3325 WLCSP EVB. Table 15 provides the descriptions of the labeled components.

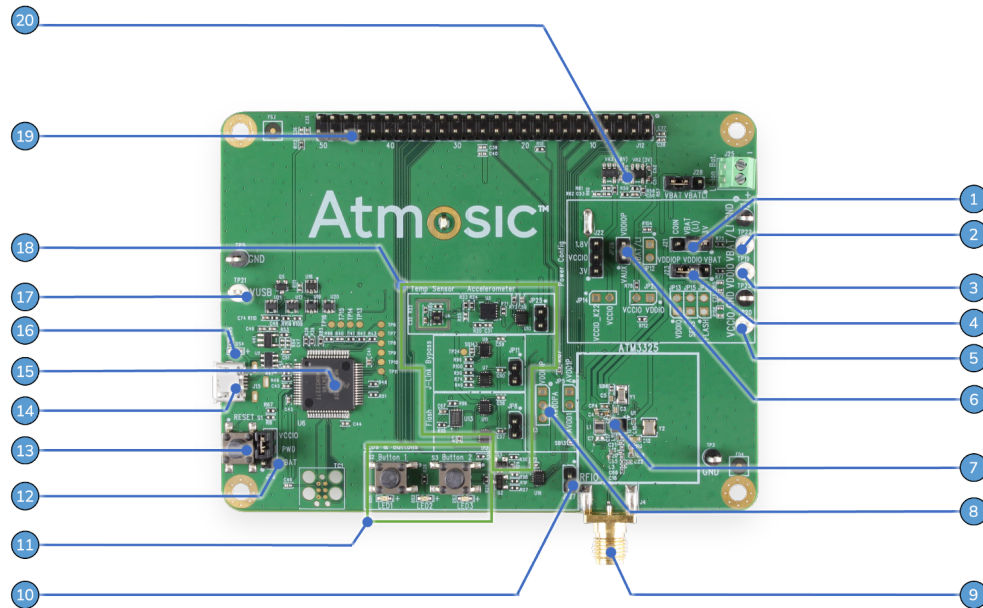

- | | | |
|---------------------------------------|-----------------------------------|--------------------------------|
| 1 - VBAT Select Jumper | 16 - USB Power LED | |
| 2 - VBAT Test Point (TP22) | 17 - USB Power Test Point (TP21) | |
| 3 - VDDIO Test Point (TP19) | 18 - Peripherals & Enable Jumpers | J-Link UART1 Disable: JP8 |
| 4 - VDDIO Select Jumper | 19 - 50-Pin Expansion Header | J-Link UART0/SWD Disable: JP11 |
| 5 - VCCIO Test Point (TP20) | 20 - 1.8V/3.0V LDOs | Sensors: JP25 |
| 6 - VDDIOP Disable Jumper | | |
| 7 - ATM3325 WLCSP Package | | |
| 8 - PA Supply Select Jumper | | |
| 9 - Bluetooth LE RFIO Connector | | |
| 10 - LED/Button Enable Jumper | | |
| 11 - General Purpose I/O | | LED1: RED |
| 12 - Reset Voltage Select Jumper | | LED2: YELLOW |
| 13 - Reset Button (S1) | | LED3: BLUE |
| 14 - Micro-B USB Connector | | Push Button 1: (S2) |
| 15 - EVB Management Processor (MK22N) | | Push Button 2: (S3) |

Figure 14 - ATM3325 WLCSP 49L Package v3.x EVB Overview

Item	Component	Description
1	VBAT Select Jumper	<ul style="list-style-type: none"> J21 is used to connect VBAT of the ATM3325 to either the 3.0 V produced by the on-board LDO or the coin cell battery in the holder (BT2) mounted on the back of the board. For power profiling of ATM3325, VBAT can also be sourced externally by a power supply at any voltage (1.1 V - 3.3 V) through TP22, without any jumpers installed on J21.
2	VBAT Test Point (TP22)	<ul style="list-style-type: none"> Provide external VBAT voltage directly to the ATM3325 (not using the LDO's), or When an arbitrary VBAT voltage (different from 3 V) is desired. <p><i>Note: When TP22 is used, no jumper should be installed on J21.</i></p>
3	VDDIO Test Point (TP19)	<ul style="list-style-type: none"> TP19 is used to provide external VDDIO voltage directly to the ATM3325's I/O (not using the LDO's). This is used for power profiling or when a VDDIO voltage other than 1.8 V or VBAT is desired for the I/O supply of the ATM3325. <p><i>Note: when TP19 is used, no jumper should be installed on J23.</i></p>
4	VDDIO Select Jumper	<ul style="list-style-type: none"> J23 is used to connect VDDIO of the ATM3325 to either VDDIOP (internally generated 1.8 V by the ATM3325) or VBAT. J22 and J23 need to be set such that VCCIO = VDDIO. For example, if VDDIO is connected to VDDIOP (using internally generated 1.8 V) then VCCIO should be connected to 1.8 V. If VDDIO is connected to VBAT and VBAT is connected to 3.0 V, then VCCIO should be connected to 3 V. If VDDIO is neither 1.8 V nor 3 V, then VCCIO should be connected to an external power supply through TP20 set to the same voltage as VDDIO.
5	VCCIO Test Point (TP20)	<ul style="list-style-type: none"> Provide external VCCIO voltage for the peripheral devices on the board, not using the LDO's. Used when the VDDIO of the ATM3325 is other than 1.8 V or 3 V because VCCIO voltage has to match VDDIO voltage. <p><i>Note: When TP20 is used, no jumper should be installed on J22.</i></p>
6	VDDIOP Disable Jumper	<ul style="list-style-type: none"> Install this Jumper JP26 when VDDIOP is not used to power VDDIO (J23) (see #4 above). <p><i>Note: Install only if VDDIOP is not used to power the PA (J3) for output</i></p>

Item	Component	Description
		<i>power greater than 4dBm</i>
7	ATM3325 WLCSP Package	ATM3325 WLCSP 49L package
8	PA Supply Select Jumper	<ul style="list-style-type: none"> ● J3 allows the option of supplying the internal ATM3325 Power Amplifier with either VDDIOP (1.8 V) or VSTORE voltage. ● By default, J3 is not installed, and the ATM3325 Power Amplifier supply is connected to VDDIOP through a solder bridge (SB144) located below J3 on the back side of the board. ● This jumper J3 applies only when the transmit power is greater than 4 dBm. ● For transmit power 4 dBm and below, the Power Amplifier uses internally supplied 1 V core voltage by default.
9	Bluetooth LE RFIO Connector	<ul style="list-style-type: none"> ● For connection to a 2.4 GHz antenna, or ● An instrument for conducted measurements.
10	LED/Button Enable Jumper	<ul style="list-style-type: none"> ● Install JP27 to enable the three LEDs (LED1, LED2, LED3) and Button 2. <ul style="list-style-type: none"> ○ When JP27 is installed, the control signals for the LEDs and Button 2 are connected to GPIOs of the ATM3325 through analog switches (U16). ○ When JP27 is open these control signals are disconnected, but there may be leakage currents of up to 5 nA per connection from the analog switches at room temperature. <p><i>Note: LED2 and LED3 are powered from the 3.3 V LDO, whereas LED1 is powered by the control signal itself.</i></p> <p><i>Note: Button 1 and Button 2 are powered by sensor supply and therefore require JP25 to be also installed for the sensor supply to be connected to VDDIO.</i></p>
11	General Purpose I/O	<ul style="list-style-type: none"> ● Install JP27 to enable functionality of the LEDs: <ul style="list-style-type: none"> ○ LED1 : RED, driven directly by P29 ○ LED2 : YELLOW, driven by P4 through a NPN transistor. ○ LED3 : BLUE, not driven by any GPIO but through a NPN transistor. However, there is TP25 nearby, which can be used to input the control signal for LED3. ● Install also JP27 to enable <ul style="list-style-type: none"> ○ Button 1 : S2 ○ Button 2 : S3

Item	Component	Description
12	Reset Voltage Select Jumper	<ul style="list-style-type: none"> J26 is used to select whether the PWD signal used to reset the ATM3325 is sourced by VBAT or VCCIO. The option to use VCCIO is useful for accurate current measurements of the ATM3325 since the PWD signal current will be drawn from VCCIO, which is a separate domain from VBAT.
13	Reset Button (S1)	<ul style="list-style-type: none"> To assert PWD to the ARM3325 (pin 12) to reset the ATM3325. This pin is pulled low by default through the resistor R8 (1M Ω). When the button is pressed, it gets pulled high to VBAT or VCCIO (see description under Reset Voltage Select Jumper above) and thus resets the ATM3325.
14	Micro-B USB Connector	<ul style="list-style-type: none"> Provide power to the EVB as well as communication to the ATM3325. The 5 V from the USB powers the three Low-Drop-Out regulators to generate 3.3 V for the MK22N processor USB block and 3.0 V and 1.8 V options for the ATM3325.
15	EVB Management Processor (MK22N)	<ul style="list-style-type: none"> Used as a translation between USB and UART and SWD. <p><i>Note: the main supply voltage level of this processor needs to match that of the I/O supply of the ATM3325.</i></p>
16	USB Power LED	<ul style="list-style-type: none"> Green LED lights up when the EVB is connected to a computer through the USB connector.
17	USB Power Test Point (TP21)	<ul style="list-style-type: none"> TP21 can be used to supply the board with an external 5 V in the case where a USB connection to the board is not available. This external 5 V will power the LDO's and enable the board to function without a host laptop, provided the ATM3325 has already been programmed and communication with a host laptop is not required. <p><i>Note: TP21 should not be used concurrently with a USB connection to a host laptop.</i></p>
18	Peripheral & Enable Jumpers	<p>J-Link UART1 Disable (JP8), J-Link UART0/SWD Disable (JP11), and Sensors (JP25)</p> <ul style="list-style-type: none"> Install JP8 to disconnect the ATM3325's UART1 lines from to the MK22N microcontroller. <ul style="list-style-type: none"> When JP8 is open, the MK22N UART1 lines are connected to the ATM3325 UART1 lines to allow communication between the ATM3325 and the host computer. The ATM3325's P21 and P27 will

Item	Component	Description
		<p>source/sink some current.</p> <ul style="list-style-type: none"> ○ When JP8 is installed, the ATM3325 UART1 lines are disconnected from the MK22N UART1 lines, but there may be leakage currents of up to 5 nA per connection from the analog switches at room temperature. This option is useful for accurate power profiling of the ATM3325 without interference from the MK22N. ● Install JP11 to disconnect the MK22N microcontroller I/O lines (UART0, SWD) from the UART0 and SWD lines of the ATM3325 by the analog switches (U7, U9). <ul style="list-style-type: none"> ○ When JP11 is open, the MK22N UART0 and SWD lines are connected to the ATM3325 UART0 and SWD lines to allow communication between the ATM3325 and the host computer. The ATM3325's P0, P1, P25, P17, P19, P20, and P30 will source/sink some current. ○ When JP11 is installed, the ATM3325 UART0 and SWD lines are disconnected from the MK22N UART0 and SWD lines, but there may be leakage currents of up to 5 nA per connection from the analog switches at room temperature. This option is useful for accurate power profiling of the ATM3325 without interference from the MK22N. ● Install JP25 to enable the temperature sensor and accelerometer. <ul style="list-style-type: none"> ○ When JP25 is installed, the supply of these two sensors are connected to VDDIO, and the I/Os of the sensors are connected to GPIOs of the ATM3325 through the analog switches (U10). ○ When JP25 is open, the sensor supply and I/Os are disconnected, but there may be leakage currents of up to 5 nA per connection from the analog switches at room temperature. ● ENS210 Temperature and Humidity Sensor <ul style="list-style-type: none"> ○ Used by the demo application including HT_thermometer or Sensor Beacon. ● LIS3DH Motion Sensor <ul style="list-style-type: none"> ○ Used by the demo application including HT_thermometer or Sensor Beacon.

Item	Component	Description
19	50-Pin Expansion Header	<ul style="list-style-type: none"> For connection to test instruments. All the GPIOs are by default available on this header.
20	1.8 V / 3.0 V LDOs	<ul style="list-style-type: none"> Supply voltages to the ATM3325 and other peripheral components using either 1.8 V or 3.0 V. These LDO's are powered by the USB power through the USB connector.

Table 15 - ATM3325 WLCSP 49L Package v3.x EVB Main Components Descriptions

In addition to the configurable jumpers described above, there are a few other jumpers on the board that are not installed by default because they are normally not needed for typical use.

All these jumpers except J22 and JP24 are shorted by default through solder bridges located immediately below them on the back side of the board.

These jumpers can be seen highlighted in green in [Figure 15](#). See [Table 16](#) for descriptions of these jumpers.

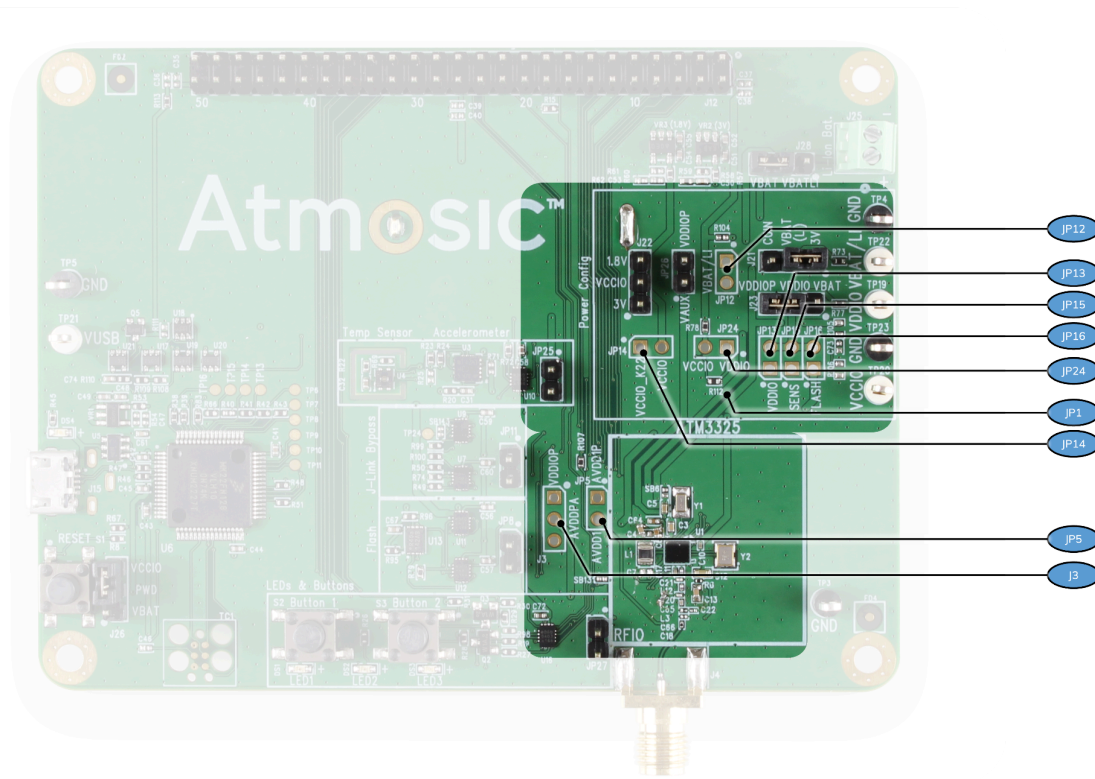

Figure 15- ATM3325 WLCSP 49L Package v3.x EVB Jumper Locations

Jumper	Solder Bridge	Description
JP12	SB136	<ul style="list-style-type: none"> In series with the net VBAT and is shorted by the solder bridge SB136 on the back side. SB136 can be cut to allow for current measurements on VBAT.
JP13	SB137	<ul style="list-style-type: none"> In series with the net VDDIO and is shorted by the solder bridge SB137 on the back side. SB137 can be cut to allow for current measurements on VDDIO.
JP15	SB140	<ul style="list-style-type: none"> In series with the net VDDIO_SENS and is shorted by the solder bridge SB140 on the back side. SB140 can be cut to allow for measurements of currents drawn by the sensors.
JP16	SB141	<ul style="list-style-type: none"> In series with the net VDDIO_FLASH and is shorted by the solder bridge SB141 on the back side. SB141 can be cut to allow for measurements of currents drawn by the external flash.
JP24	N/A	<ul style="list-style-type: none"> By default not installed and not shorted by a solder bridge. If installed, it would connect the peripheral supply VCCIO with the ATM3325 VDDIO supply, useful for the case where USB supply is not available.
JP1	SB2	<ul style="list-style-type: none"> In series with the net DVDD1 and is shorted by the solder bridge SB2 on the back side. SB2 can be cut to allow for current measurements on DVDD1.
JP14	SB138	<ul style="list-style-type: none"> In series with the net VCCIO_K22 and is shorted by the solder bridge SB138 on the back side. SB138 can be cut to allow for measurements of currents drawn by the MK22N processor.
JP5	SB9	<ul style="list-style-type: none"> In series with the net AVDD1 and is shorted by the solder bridge SB9 on the back side. SB9 can be cut to allow for current measurements on AVDD1.

Jumper	Solder Bridge	Description
JP3	SB144	<ul style="list-style-type: none"> J3 allows the option of supplying the internal ATM3325 Power Amplifier with either VDDIOP (1.8 V) or VSTORE voltage. By default, J3 is not installed, and the ATM3325 Power Amplifier supply is connected to VDDIOP through a solder bridge (SB144) located below J3 on the back side of the board. This jumper J3 applies only when the transmit power is greater than 4 dBm. For transmit power 4 dBm and below, the Power Amplifier uses internally supplied 1 V core voltage by default.

Table 16 - ATM3325 WLCSP 49L Package v3.x EVB Jumpers Descriptions

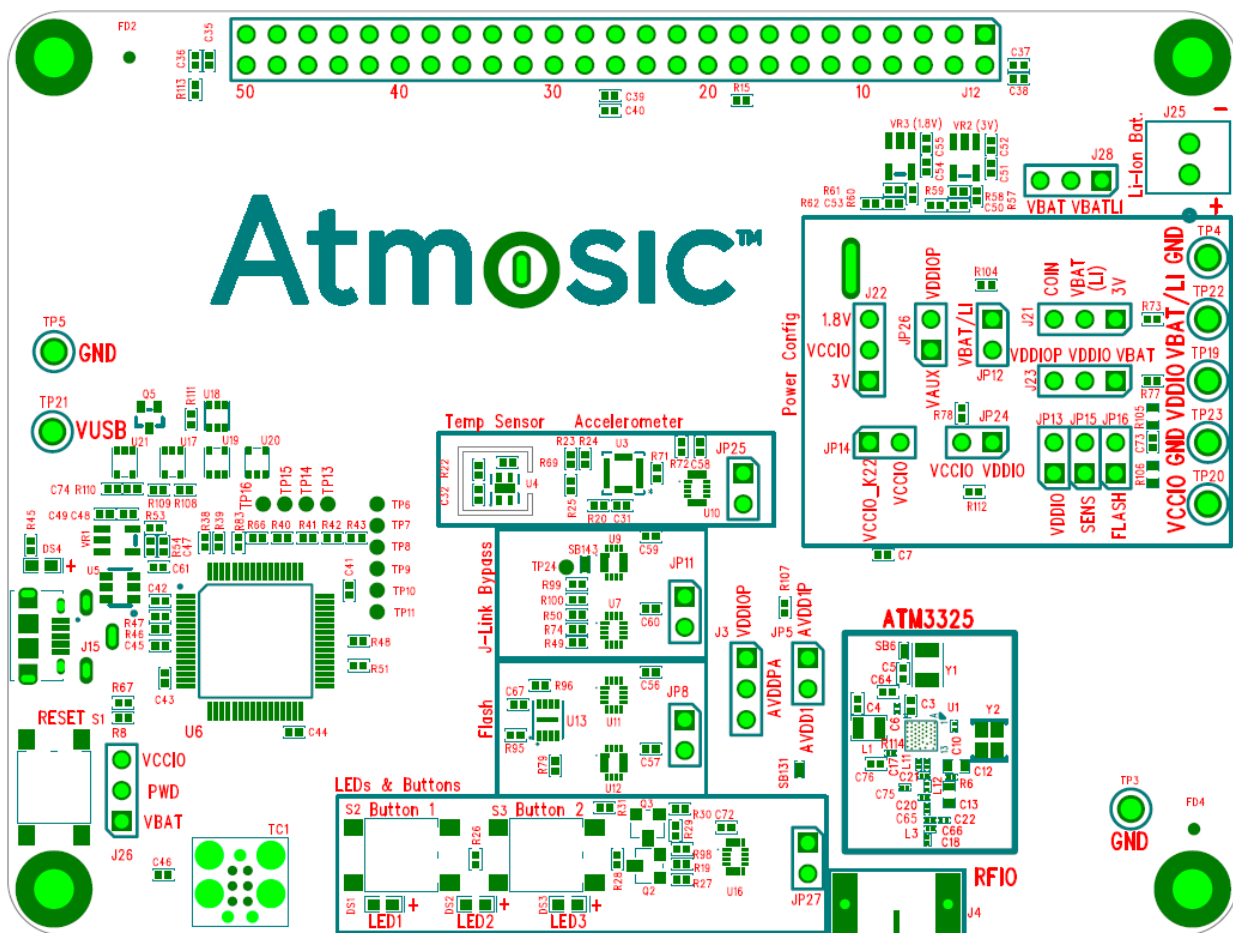

Figure 16 - ATM3325 WLCSP 49L Package v3.x EVB Top Silkscreen

The jumpers on the EVB have been configured for the following default mode of operation. See [Table 17](#).

Default Configuration	Jumper
The ATM3325's main supply VBAT comes from the coin cell battery	J21
The ATM3325 uses internal IO voltage supplied by 1.8 V VDDIOP	J23
UART1 signals are routed to the MK22N	JP8 not installed
Sensors are NOT powered and NOT connected to the ATM3325 GPIOs	JP25 not installed
LEDs and Buttons are NOT powered and NOT connected to the ATM3325 GPIOs	JP27 not installed
SWD and UART0 signals are routed to the MK22N	JP11 not installed

Table 17 - ATM3325 WLCSP 49L Package v3.x EVB Default Configurations

3.7 EVB Reconfiguration

To reconfigure the EVB, the user can easily add, remove, or move jumpers. The EVB can also be further modified to allow for detailed current measurements if desired by cutting solder bridges and installing jumpers as previously mentioned.

To cut a solder bridge, simply use a blade to cut the thin trace that connects the two pads of the solder bridge. To short/close a solder bridge, simply use a soldering iron and some solder to fuse the two pads together. A microscope may be needed to make sure the connection has been thoroughly cut or fused.

The rest of this document describes the steps required to power and configure the EVB.

4. VDDIO Voltage

The EVB is configured out of box to support VDDIO of 1.8 V. It can be reconfigured to be the same as VBAT by moving the jumper on J23. In this case, JP26 should be installed if the Power Amplifier is not set to output more than 4dBm.

For VDDIO voltages other than these two options, an external power supply should be used. The user needs to match the software settings along with the board configurations. Please refer to [Reconfigure the EVB](#) section for examples.

5. Powering on the EVB via the USB Connector

The EVB is configured out of the box to send out Bluetooth LE advertisement beacons once the coin cell battery included in the kit is inserted into the holder at the back side of the EVB, without the need of a PC.

Alternatively, the EVB can also be powered through the USB connector. To do that, connect the EVB to a PC using the supplied USB cable. The green USB Power LED next to the USB connector of the EVB should light up indicating that it is receiving 5 V from the PC's USB port. J21 can then be set to 3 V to power the ATM33/e by the on-board 3 V LDO.

The beacons can be detected over the air by any Bluetooth sniffer phone app if the 2.4 GHz antenna (the shorter of the two antennas included in the kit) is connected to the SMA connector labeled RFIO and the phone is placed close to the EVB.

6. Windows Driver Configurations

This Zadig tool is used to check and install the correct WinUSB driver needed for the Atmosic EVKs. This step is not required if the system has already been installed with Atmosic SDK and RDI driver.

Once the EVB is connected to a PC via the USB port:

- Launch the app [Zadig](#) (3rd Party Tool) on the PC.
- Click on `Options` and choose `List all devices`.
- From the drop down menu at the top of the window, choose `BULK interface (Interface 4)`.

The window should look as shown below in [Figure 17](#).

If the driver listed on the left-hand side is not WinUSB (v6.1.7600.16385), click on the button `Replace Driver` to replace it with WinUSB (v6.1.7600.16385), which is the needed driver for the PC to communicate with the EVB.

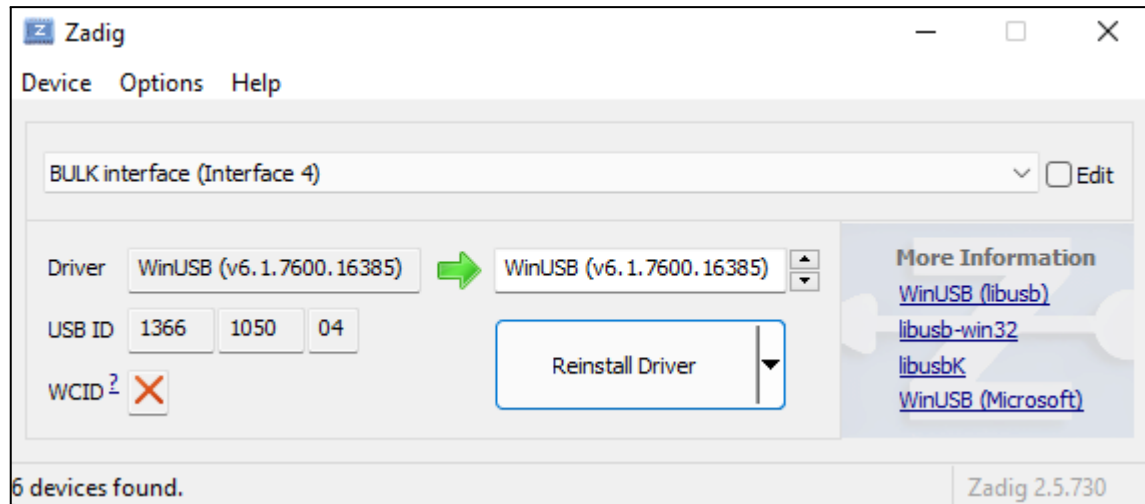

Figure 17 - Correct Windows Driver for the EVB

The EVB is now ready for software tools such as openOCD and Atmosic SDK and other IDE tools like Keil MDK, IAR Workbench etc. The push button S1 on the EVB (next to the USB connector) can be used to power reset the ATM33/e if a new application does not run after it has just been downloaded.

7. Reconfigure the EVB

Here are a few examples to reconfigure the EVB. Please refer to the **ATM33_e Series Reference Manual** 'PMU Configurations' section for the actual software settings.

Example 1: The default EVB assumes a non-rechargeable battery on VBAT. To reconfigure the device to use VBATLI, please refer to **ATM33/e Energy Harvesting EVK Quick Start Guide** and **ATM33_e Support for External Storage Devices Application Note**.

Example 2: The default EVB assumes $VBAT > 1.8\text{ V}$. To reprogram the device for $VBAT \leq 1.8\text{ V}$, the following procedure needs to be followed:

- 1) power the device with $VBAT > 1.8\text{ V}$.
- 2) reprogram the device to indicate $VBAT \leq 1.8\text{ V}$.
- 3) supply the device with VBAT at the target level.
- 4) proceed with evaluation.

Example 3: The default EVB assumes internally generated I/O supply. To reprogram the device for external I/O supply, the following procedure needs to be followed:

- 1) power down the device.
- 2) change the hardware jumpers according to [VDDIO Voltage](#) section.
- 3) power up the device.
- 4) reprogram the device to indicate externally generated I/O supply.
- 5) proceed with evaluation.

Reference Documents

Title	Document Number
ATM33e Series Datasheet	ATM33e-DS
ATM33 Series Datasheet	ATM33-DS
ATM33/e Series Reference Manual	ATM33_e-RM
ATM33/e Energy Harvesting EVK Quick Start Guide	ATM33_e-QSGEH
ATM33/e EVK Power Consumption Evaluation User Guide	ATM33_e-UGPCE
ATM33/e Support for External Storage Devices Application Note	ATM33_e-ANSESD
IAR Workbench User Guide	ATM-UGIAR
Keil MDK Configuration Guide	ATM-CGKMDK
SDK 5.3.0 or later Release Notes	ATM-RNSDK5x0
SDK User Guide	ATM-QSGSDK
SEGGER Embedded Studio User Guide	ATM-UGSEG

Revision History

Date	Version	Description
January 23, 2024	0.67	Updated Figure 2 - ATM3330/e 7x7 mm Package v3.x... , Figure 5 - ATM3330/e 7x7 mm Package v4.x... , Figure 6 - ATM3330/e 7x7 mm Package v4.x... , Table 5 - ATM3330/e 7x7 mm Package v4.x... , Table 7 - ATM3330/e 7x7 mm Package v4.x... , Table 8 - ATM3330e v4.x EVB Boosting Options Jumper Configurations , 3.3.1 Boosting Circuit Configuration on ATM3330/e EVB v4.x
August 18, 2023	0.66	Updated Table 1 - Applicable SoCs and EVKs , Figure 2 - ATM3330/ATM3330e v3.x 7x7 mm Package EVB Overview , Figure 5 - ATM3325 5x5 mm Package v3.x EVB Overview , Table 5 - ATM3325 EVB Main Components Descriptions , Figure 6 - ATM3325 EVB Jumper Locations , Table 6 - ATM3325 EVB Jumpers Descriptions , Figure 7 - ATM3325 EVB Top Silkscreen , Table 7 - ATM3325 EVB Default Configurations , Figure 8 - ATM3325 with Extended Storage 5x5 mm Package v3.x EVB Overview , Table 8 - ATM3325 with Extended Storage 5x5 mm Package v3.x EVB Main Components Descriptions , VDDIO Voltage , Windows Driver Configurations sections. Added ATM3325 WLCSP EVB Description section.
March 10, 2022	0.65	Updated Overview , Figure 1 - ATM3330/e Evaluation Kit through Figure 7 - ATM3325 EVB Top Silkscreen , Table 2 - ATM3330/e EVB Main Components Descriptions , Table 6 - ATM3325 EVB Jumpers Descriptions .
August 31, 2022	0.64	Updated Overview section, Table 1 - ATM33/e EVB Main Components Descriptions , format change.
August 16, 2022	0.63	Updated various sections for EVB based on ATM3330/ATM3330e and ATM3325 Rev. B0.
June 1, 2022	0.62	Corrected typos.

February 15, 2022	0.61	Added VDDIO Voltage Support section.
January 31, 2022	0.60	Major update throughout the document.
December 3, 2021	0.51	Changed part number, no content change.
November 9, 2021	0.50	Initial version created.



ATMOSIC TECHNOLOGIES – DISCLAIMER

This product document is intended to be a general informational aid and not a substitute for any literature or labeling accompanying your purchase of the Atmosic product. Atmosic reserves the right to amend its product literature at any time without notice and for any reason, including to improve product design or function. While Atmosic strives to make its documents accurate and current, Atmosic makes no warranty or representation that the information contained in this document is completely accurate, and Atmosic hereby disclaims (i) any and all liability for any errors or inaccuracies contained in any document or in any other product literature and any damages or lost profits resulting therefrom; (ii) any and all liability and responsibility for any action you take or fail to take based on the information contained in this document; and (iii) any and all implied warranties which may attach to this document, including warranties of fitness for particular purpose, non-infringement and merchantability. Consequently, you assume all risk in your use of this document, the Atmosic product, and in any action you take or fail to take based upon the information in this document. Any statements in this document in regard to the suitability of an Atmosic product for certain types of applications are based on Atmosic's general knowledge of typical requirements in generic applications and are not binding statements about the suitability of Atmosic products for any particular application. It is your responsibility as the customer to validate that a particular Atmosic product is suitable for use in a particular application. All content in this document is proprietary, copyrighted, and owned or licensed by Atmosic, and any unauthorized use of content or trademarks contained herein is strictly prohibited.

Copyright ©2021-2023 by Atmosic Technologies. All rights reserved. Atmosic logo is a registered trademark of Atmosic Technologies Inc. All other trademarks are the properties of their respective holders.

Atmosic™

Atmosic Technologies | 2105 S. Bascom Ave. | Campbell CA, 95008

www.atmosic.com