

Atmosic RF Test Tool

User Guide

SUMMARY: The document provides instructions on how to install and operate the Atmosic RF Test Tool to test Tx and Rx RF performance, and Tx output power of the ATM2/ATM3, ATM33/e, or ATM34/e Wireless SoC Series. The RF Test Tool can also be used for Rx sensitivity measurements, FCC/CE pretest, and certification.



Atmosic™

Doc. No. ATM-UGRF-0062

Table of Contents

User Guide	1
Table of Contents	2
List of Figures	3
List of Tables	3
Acronyms and Abbreviations	4
1. Overview	5
2. Hardware and Software Requirements	5
2.1 Supported EVK	5
2.2 Supported SDK	6
2.3 Supported OS	6
2. Environment Setup	6
2.1 Setup Software	8
2.1.1 Install WinUSB Driver Using Zadig	8
2.1.2 Program Firmware	10
2.1.3 Launch RF test tool	11
2.2 UART Ports	11
2.3 Running the RF Test Tool	13
3. RF Test Functions	15
3.1 Tx Test	17
3.1.1 Burst Tx Mode	18
3.1.2 Infinite Tx Mode	18
3.1.3 Single-Tone Transmission	19
3.2 Rx Test	19
3.2.1 Rx Mode	19
4. Check the DUT RF Function Using the RF Test Tool	19
5. 16 MHz Crystal Calibration Using RF Test Tool	21
6. ATM34/e 802.15.4 RF Test	23
References	25
Revision History	26

List of Figures

- Figure 1 - RF Test Tool Hardware Environment for the ATM2/ATM33
- Figure 2 - RF Test Tool Hardware Environment for the ATM33/e
- Figure 3 - Replace Driver Using Zadig
- Figure 4 - Replace Driver for ATM2/ATM3 Using Zadig
- Figure 5 - Run program_by_openocd.bat File in RF Test Tool Folder
- Figure 6 - Run program_by_openocd.bat File in RF Test Tool Folder for ATM33/e
- Figure 7 - runui.bat File in RF Test Tool Folder
- Figure 8 - New COM Ports from the Interface Board of ATM2/ATM3 EVK
- Figure 9 - New COM Ports from the ATM3330e/ATM3330 EVK
- Figure 10 - RF Test Tool Interface Setting
- Figure 11 - Reset the EVK
- Figure 12 - RF Test Tool User Interface and Test Items
- Figure 13 - ATM2/ATM3 EVK Tx Test Environment Setting
- Figure 14 - ATM33/e EVK Tx Test Environment Setting
- Figure 15 - Test Environment to Check DUT RF Function Using RF Test Tool for the ATM2/ATM3
- Figure 16 - Test Environment to Check DUT RF Function Using RF Test Tool for the ATM33/e
- Figure 17 - Calibration iterations in RF Tool
- Figure 18 - Calibration result in RF Tool
- Figure 19 - Configure baud rate for ATM34 CHCI firmware
- Figure 20 - CHCI RF Test interface
- Figure 21 - CHCI Rx/Tx pair test with two boards

List of Tables

- Table 1 - Radio Tests Descriptions
- Table 2 - Supported ATM33/e SoCs and EVKs

Acronyms and Abbreviations

Acronyms	Definition
ATM2	ATM2201 ATM2202 ATM2221 ATM2231 ATM2251
ATM3	ATM3201 ATM3202 ATM3221 ATM3231
ATM33/e	ATM3325 ATM3330 ATM3330e
ATM34/e	ATM3405 ATM3425 ATM3430e
Bluetooth LE	Bluetooth Low Energy
EVB	Evaluation Board
EVK	Evaluation Kit
SDK	Software Development Kit
SoC	System on Chip

1. Overview

This document provides instructions on how to install and operate the Atmosic RF Test Tool to test the following functions:

- Tx and Rx RF performance
- Tx output power

The RF Test Tool can also be used for Rx sensitivity measurements, FCC/CE pretest, and certification.

2. Hardware and Software Requirements

The RF tool supports the following devices:

- ATM2/ATM3 series
- ATM33/e series
- ATM34/e series

2.1 Supported EVK

There are multiple versions of the ATM2/ATM3 EVKs based on the specific device and package configuration. See [Table 1](#).

EVK	SoC Package	SoC Part Number	Kit Part Number
Evaluation Kit for ATM2202	40-pin 5x5 mm QFN	ATM2202SR	ATMEVK-M2202-02
Evaluation Kit for ATM2221	64-pin 6x6 mm QFN	ATM2221SR	ATMEVK-M2221-02
Evaluation Kit for ATM2251	37L WLCSP	ATM2251SR	ATMEVK-M2251-01
Evaluation Kit for ATM3201	40-pin 5x5 mm QFN	ATM3201SR	ATMEVK-M3201-02
Evaluation Kit for ATM3202	40-pin 5x5 mm QFN	ATM3202SR	ATMEVK-M3202-02
Evaluation Kit for ATM3221	64-pin 6x6 mm DR_QFN	ATM3221SR	ATMEVK-M3221-02

Table 1 - Supported ATM2/ATM3 SoCs and EVKs

EVK	SoC	SoC Part Number	Kit Part Number
Evaluation Kit for ATM3325	40-pin 5x5 mm QFN	ATM3325-5DCAQK	ATMEVK-3325-QK
Evaluation Kit for ATM3325 with extended storage	40-pin 5x5 mm QFN	ATM3325-5LCAQK	ATMEVK-3325-LQK
Evaluation Kit for ATM3325 WLCSP	49L WLCSP	ATM3325-5DCACM	ATMEVK-3325-CM
Evaluation Kit for ATM3330	56-pin 7x7 mm QFN	ATM3330-5DCAQN	ATMEVK-3330-QN
Evaluation Kit for ATM3330e	56-pin 7x7 mm QFN	ATM3330E-5DCAQN	ATMEVK-3330e-QN

Table 2 - Supported ATM33/e SoCs and EVKs

EVK	SoC	SoC Part Number	Kit Part Number
Evaluation Kit for ATM3405	40-pin 5x5 mm QFN	ATM3405-2PCAQK	ATMEVK-3405-PQK-2
Evaluation Kit for ATM3425	40-pin 5x5 mm QFN	ATM3425-2PCAQK	ATMEVK-3425-PQK-2
Evaluation Kit for ATM3430e	56-pin 7x7 mm QFN	ATM3430E-2WCAQN	ATMEVK-3430e-WQN-2

Table 3 - Supported ATM34/e SoCs and EVKs

2.2 Supported SDK

For ATM2/ATM3 and ATM33/e series, the Atmosic SDK 5.3.0 or later can be used with the EVK. For the ATM34/e series, the Atmosic SDK 6.0.0 or later can be used with the EVK. Refer to the SDK User Guide for more information.

Note: The RF Test Tool can also be used independently without the Atmosic SDK.

2.3 Supported OS

The RF Test Tool can be used with Windows 10 or Windows 11.

2. Environment Setup

A complete set of the test suite includes:

- PC (Windows 10, 11)
- ATM2/ATM3 EVK (includes Atmosic Interface Board) or

- ATM33/e EVK or
- ATM34/e EVK
- Type A to Micro USB cable

See the [References](#) section for additional information.

[Figure 1](#) shows the connection setup between the PC, Interface board, and EVK for the ATM2/ATM3.

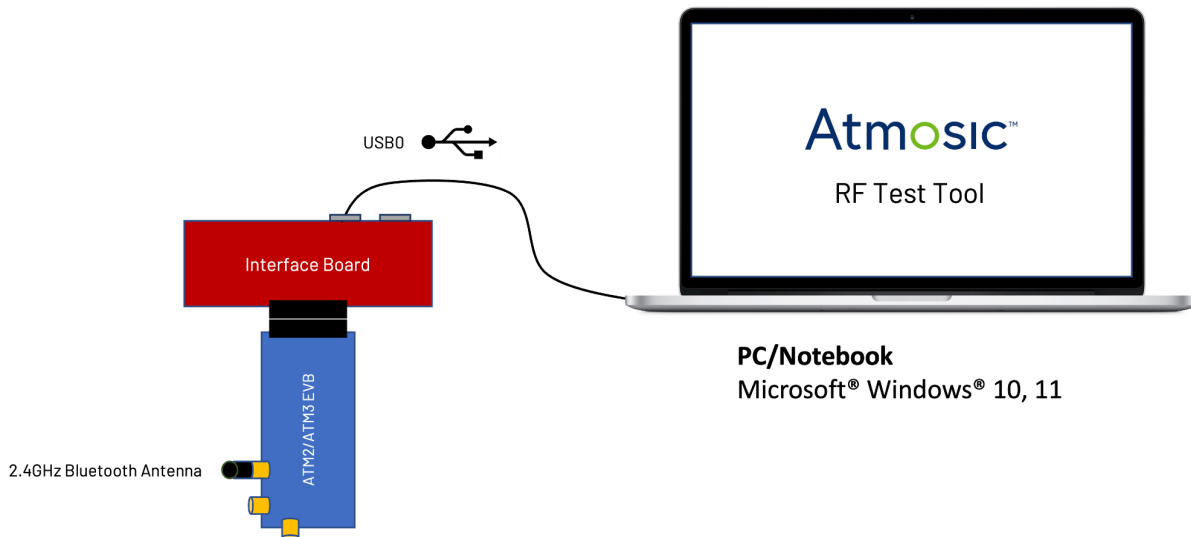

Figure 1 - RF Test Tool Hardware Environment for the ATM2/ATM3

[Figure 2](#) shows the connection setup between the PC and the ATM33/e Evaluation Board (EVB).

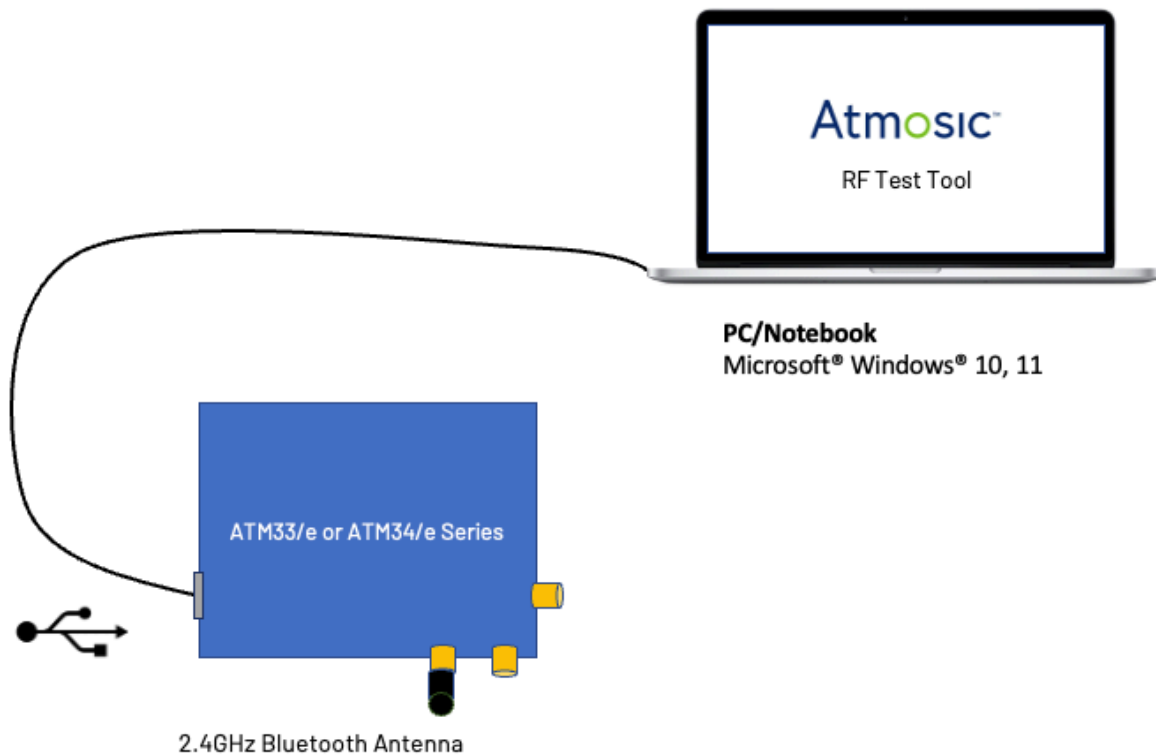

Figure 2 - RF Test Tool Hardware Environment for the ATM33/e or ATM34/e

2.1 Setup Software

- The tool is available at the Atmosic Support website under
 - Tools
 - rftool_vx.y.z.zip
- Extract the .zip file

2.1.1 Install WinUSB Driver Using Zadig

This Zadig tool is used to check and install the correct WinUSB driver needed for the Atmosic EVKs. This step is not required if the system has already been installed with Atmosic SDK and RDI driver.

Windows Administrator privileges are required for replacing a driver. Zadig can be obtained from:

<https://github.com/pbatard/libwudi/releases>

At the time of this writing, the latest version -- 2.4 -- can be obtained using the following direct link. <https://github.com/pbatard/libwudi/releases/download/b721/zadig-2.4.exe>

To replace the driver:

- 1) From the Options menu of Zadig, click **List all devices**.
- 2) From the drop-down menu, find the **BULK interface** or **Atmosic RDI USB** corresponding to the Atmosic board. It should show **jlink (v...)** or **FTDIBUS (v...)** as the current driver on the left.
- 3) Select **WinUSB (v...)** as the replacement on the right.
- 4) Click **Replace Driver**.

Refer to [Figure 3](#) and [Figure 4](#).

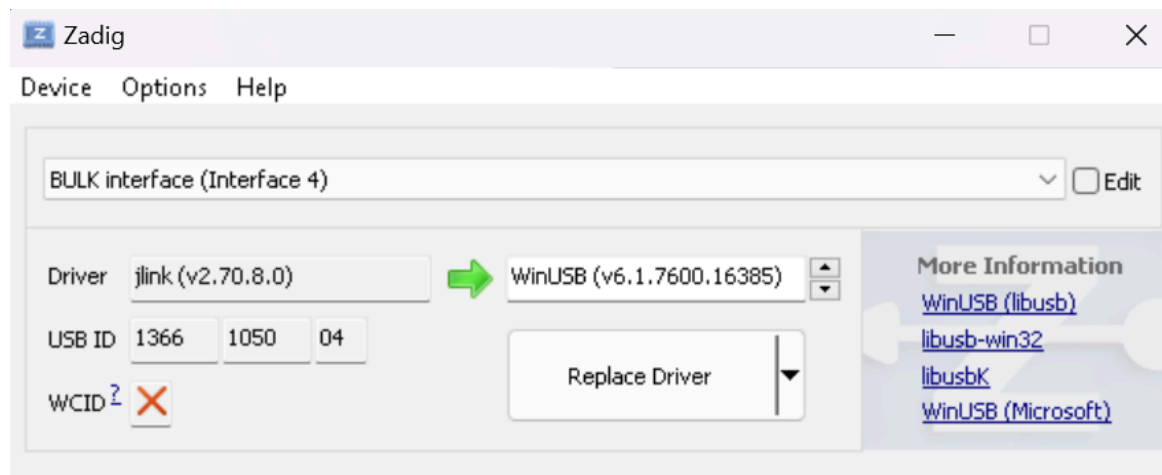

Figure 3 - Replace Driver for ATM33/e or ATM34/e Using Zadig

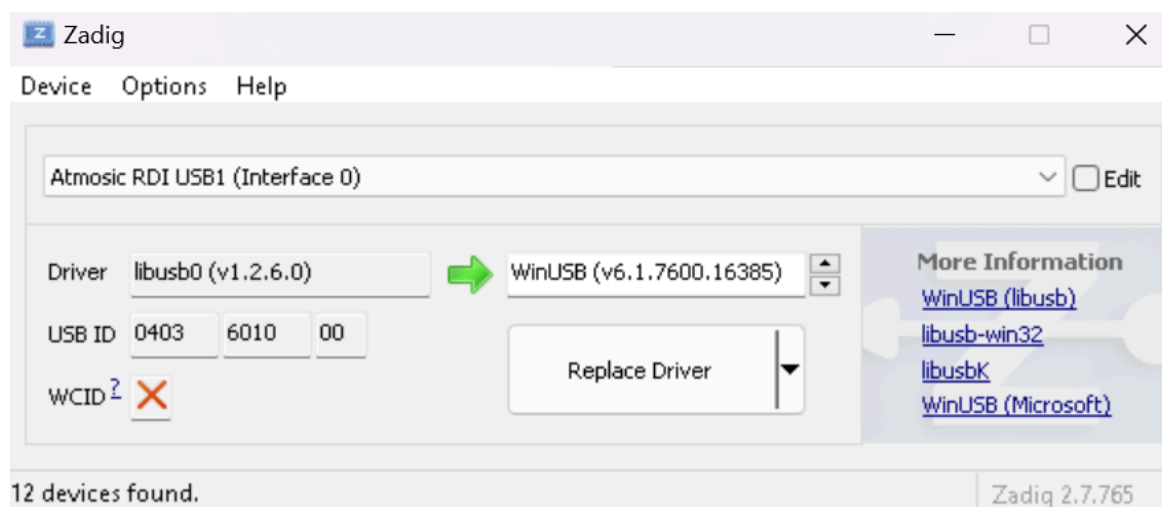

Figure 4 - Replace Driver for ATM2/ATM3 Using Zadig

Verify the successful installation of WinUSB by accessing the Windows Device Manager and confirming it is the BULK interface driver rather than the J-Link driver. (In Device Manager, expand the category Universal Serial Bus devices and look for the BULK interface.)

2.1.2 Program Firmware

The tool communicates with the HCI_vendor firmware of EVK via the UART interface. If your board already has this firmware loaded, you can skip programming the pre-built HCI_vendor image mentioned in this section. Please note that the pre-built HCI_vendor image may be outdated. It is recommended to program the HCI_vendor example code using the latest Atmosic SDK.

For ATM33/e devices, double-click on the program_by_openocd.bat file in the RF Tool folder to execute, then follow the menu to select ATM33xx-5 or other part numbers to program FW as shown in [Figure 6](#).

For the ATM2/ATM3 or ATM34/e devices, double click on the program_by_openocd.bat file in the RF Tool folder to execute, then follow the menu to select ATMx2xx-x1x or ATM34xx-2 depending on EVK to program FW. See [Figure 5](#).

The console will guide you through the selection of the right firmware images for the different boards. See [Figure 6](#).

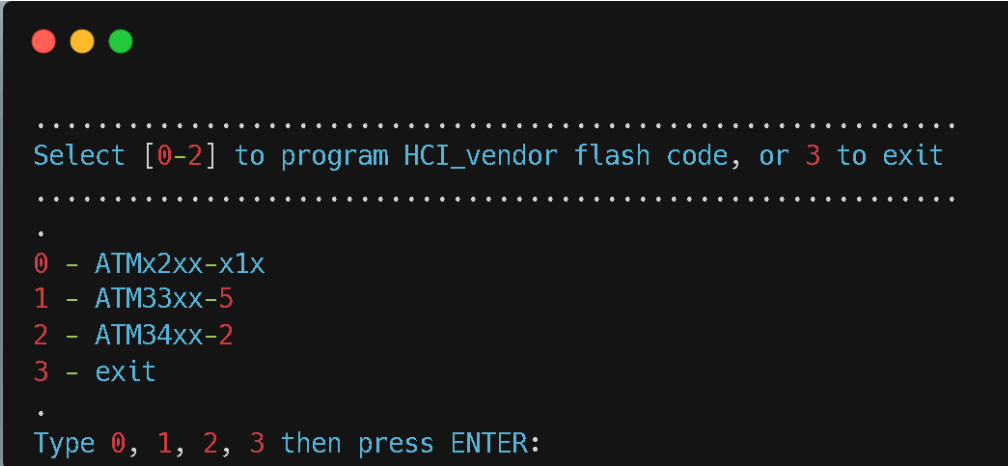

```
.....  
Select [0-2] to program HCI_vendor flash code, or 3 to exit  
.....  
.  
0 - ATMx2xx-x1x  
1 - ATM33xx-5  
2 - ATM34xx-2  
3 - exit  
.  
Type 0, 1, 2, 3 then press ENTER:
```

Figure 5 - Run the program_by_openocd.bat File in the RF Test Tool Folder to select the platform

```

Select [0-4] to program HCI_vendor flash code, or 5 to exit
.....
.
0 - ATMEVK_3325_LQK
1 - ATMEVK_3325_QK
2 - ATMEVK_3325_TAG
3 - ATMEVK_3330_QN
4 - ATMEVK_3330e_QN
.
Type 0, 1, 2, 3, 4, 5 then press ENTER:

```

Figure 6 - Run the `program_by_openocd.bat` File in the RF Test Tool Folder for programming the firmware for the selected board under the previously selected platform.

2.1.3 Launch RF test tool

Double-click on the `runui.bat` file in the RF Test Tool folder to execute after the DUT is powered on properly as [Figure 7](#).

fw_image	3/9/2022 12:03 AM	File folder	
mpf.bat	3/9/2022 12:03 AM	Windows Batch File	2 KB
notice_matplot.txt	3/9/2022 12:03 AM	Text Document	3 KB
notice_numpy.txt	3/9/2022 12:03 AM	Text Document	2 KB
notice_pyinstaller_3.5.txt	3/9/2022 12:03 AM	Text Document	19 KB
notice_pyserial.txt	3/9/2022 12:03 AM	Text Document	2 KB
notice_python_3.7.txt	3/9/2022 12:03 AM	Text Document	3 KB
README	3/9/2022 12:03 AM	File	7 KB
Atmosic rftool.exe	3/9/2022 12:05 AM	Application	36,474 KB
runui.bat	3/9/2022 12:03 AM	Windows Batch File	1 KB

Figure 7 - `runui.bat` File in the RF Test Tool Folder

2.2 UART Ports

For the ATM2/ATM3, connect the EVB to the interface board:

- Plug the USB cable to USB0 (port J6) of the interface board (part of the Evaluation Kit) as shown below. Do not plug a second USB cable into USB1 (port J5) of the interface board.

- Plug the other end of the USB cable into the Windows computer, Windows will install the FTDI USB-to-serial driver automatically. After the driver is installed, the device shows as a COM port in the Windows Device Manager. See [Figure 8](#).

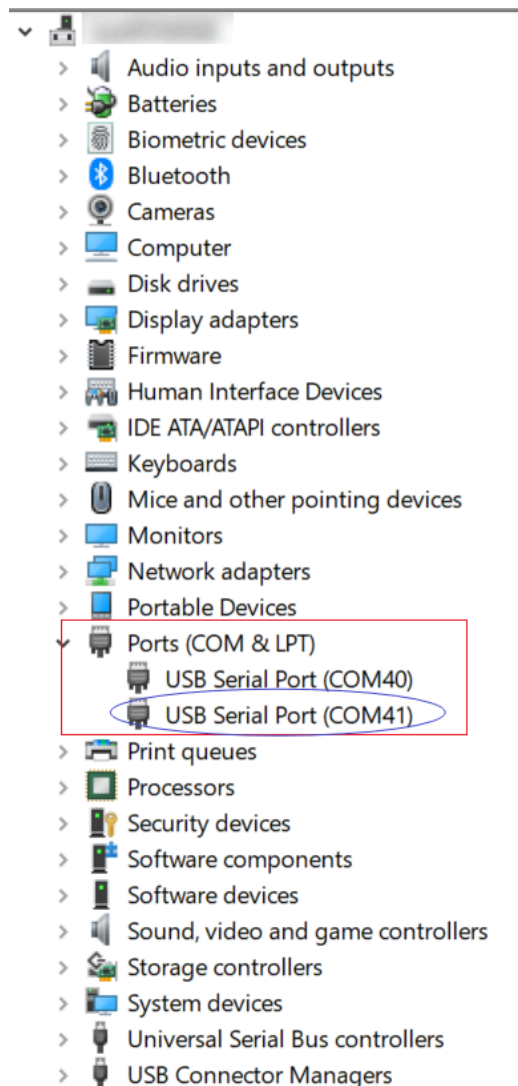

Figure 8 - New COM Ports from the Interface Board of ATM2/ATM3 EVK

For the ATM33/e or ATM34/e, after connecting the USB connector to the Windows laptop, there are two USB ports from JLink CDC UART ports as shown in [Figure 9](#).

One is the console output and the other is the HCI interface port working with the RF Test Tool.

The console UART port uses a 115200 baud rate and the HCI interface port uses a 460800 baud rate.

RF Test Tool will have the interface to select COM<N>, where <N> is the COM port sequence number depending on Windows OS.

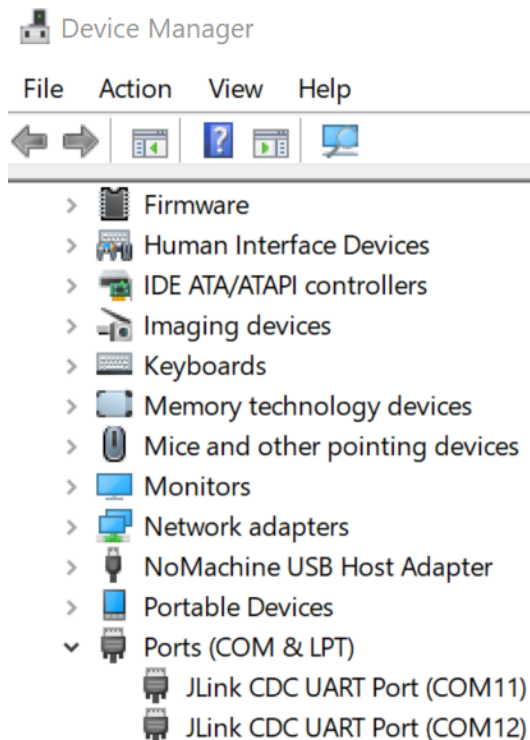

Figure 9 - New COM Ports from the ATM3330e/ATM3330 EVK

2.3 Running the RF Test Tool

Connect the ATM2/ATM3, ATM33/e, or ATM34/e EVK to a Windows laptop and execute `runui.bat`.

Command window pops up:

```
W:\RFtool\release>rftool --gui
1[Warn  ]not find .ini(AtmosicRFTool.ini) file or section name(uartsave)
2[Trace ]call enum_comport
3[Trace ]Device-COM3, description-JLink CDC UART Port (COM3)
4[Trace ]Device-COM4, description-USB Serial Port (COM4)
5[Trace ]Device-COM11, description-JLink CDC UART Port (COM11)
7[Error ]COM port is not Ready
8[Error ]COM port is not Ready
```

Select the correct platform. Select the correct baud rate for the COM port. The default baud rate is configured as **460800** bps for the prebuilt HCI_vendor firmware image. Select a different baud rate if you have a different setting on a customized image. Click Open COM of RF Test Tool GUI to connect to the DUT. Then click the Radio Test item to enter the parameter setting windows as shown in [Figure 10](#).

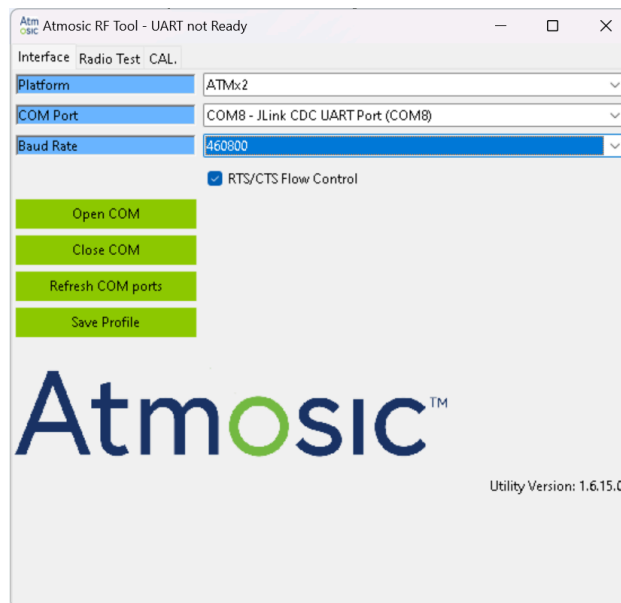

Figure 10 - RF Test Tool Interface Setting

Click the Reset button on the RF Test Tool GUI.

If the command window shows that the Reset command was successful, you can control the EVK via the Atmosic RF Test Tool as shown in [Figure 11](#).

If the command window does not show the successful message, close the RF Test Tool and re-open it to try another UART COM port.

If not using ATM2/ATM3, ATM33/e, ATM34/e EVK, or using an outdated HCI_vendor image, please contact Atmosic FAE, or [submit a support request](#), on how to build/program the HCI_vendor of Atmosic SDK, configure the baud rate, disable UART flow control, and UART pin assignment.

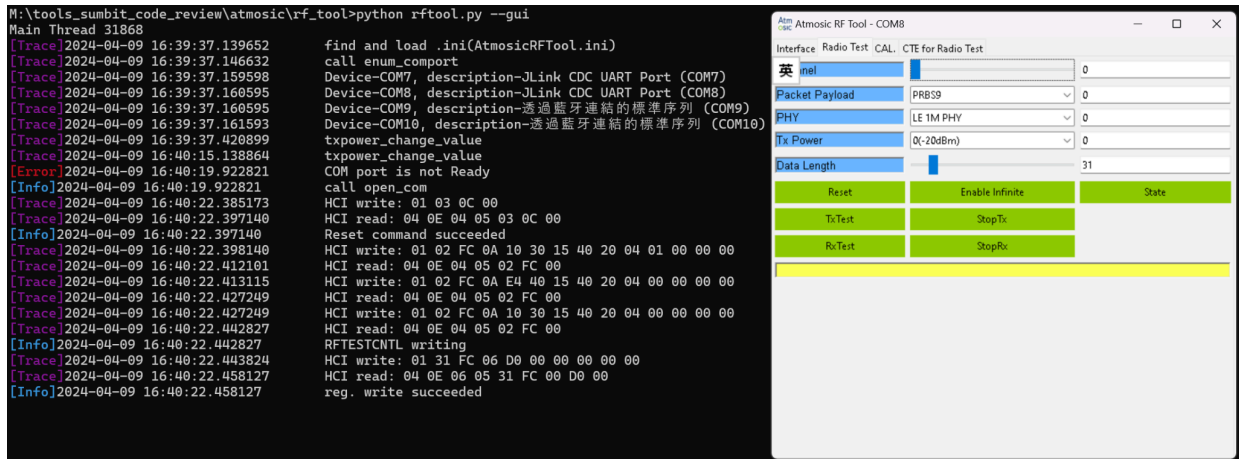

Figure 11 - Reset the EVK

3. RF Test Functions

The RF Test Tool can control the ATM2/ATM3, ATM33/e, or ATM34/e devices to enter Tx test mode or Rx test mode.

Tx test includes three modes:

- Burst Tx mode
- Infinite Tx mode
- Single tone mode

Rx test mode supports counting the number of packets received through appropriate settings.

[Figure 12](#) shows the RF Test Tool user interface and test items. Detailed descriptions of the test items are in [Table 1](#).

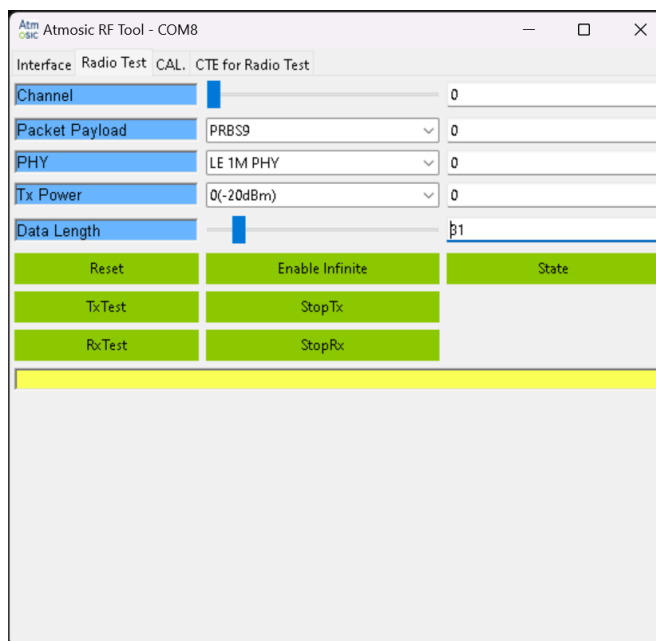

Figure 12 - RF Test Tool User Interface and Test Items

Name	Description	Notes
Channel	Bluetooth LE RF channel	There are 40 channels from CH0 (2402 MHz) to CH39 (2480 MHz). It can be adjusted by typing or by using the slider.
Packet Payload	Bluetooth LE standard packet payload format	Packet Payload includes: PRBS9/ 11110000 /10101010/ PRBS15/ 11111111/00000000/00001111/01010101
PHY	RF PHY	RF PHY includes: LE 1M PHY/ LE 2M PHY/ LE Coded PHY(S=2)/ LE Coded PHY(S=8) / Single Tone
Tx Power	Tx output power setting	Tx output power level includes: 10 dBm/ 8 dBm/ 6 dBm/ 4 dBm/ 2 dBm/ 0 dBm/ -2 dBm/ -4 dBm/ -6 dBm / -8 dBm/ -10 dBm/ -20 dBm
Data Length	Payload length	The payload length range is from 1 to 255. It can be adjusted by typing or by using the slider
Reset	HCI reset command	HCI reset command: 0x01030C00
Enable Infinite (Disable Infinite)	Enable/Disable Infinite Tx mode	Enable or disable Infinite Tx mode. With this button, all the PHY settings can be defined as the “Infinite Tx mode” or “Burst Tx mode”.
State	Burst Tx mode or Infinite Tx mode	Display the infinite state in the command window. Infinite Tx mode, show “infinite is 1” Burst Tx mode, show “infinite is 0”

Name	Description	Notes
TxTest	Turn on Tx function	Start transmitting the RF signal
StopTx	Turn off Tx function	Stop transmitting the RF signal
RxTest	Turn on Rx function	Start receiving the RF signal
StopRx	Turn off Rx function	Stop receiving the RF signal

Table 1 - Radio Test Descriptions

3.1 Tx Test

Three modes are supported in the Tx Test:

- Burst Tx mode
- Infinite Tx mode
- Single tone mode

[Figure 13](#) and [Figure 14](#) show the ATM2/ATM3 EVK and ATM33/e or ATM34/e EVK Tx test environment respectively.

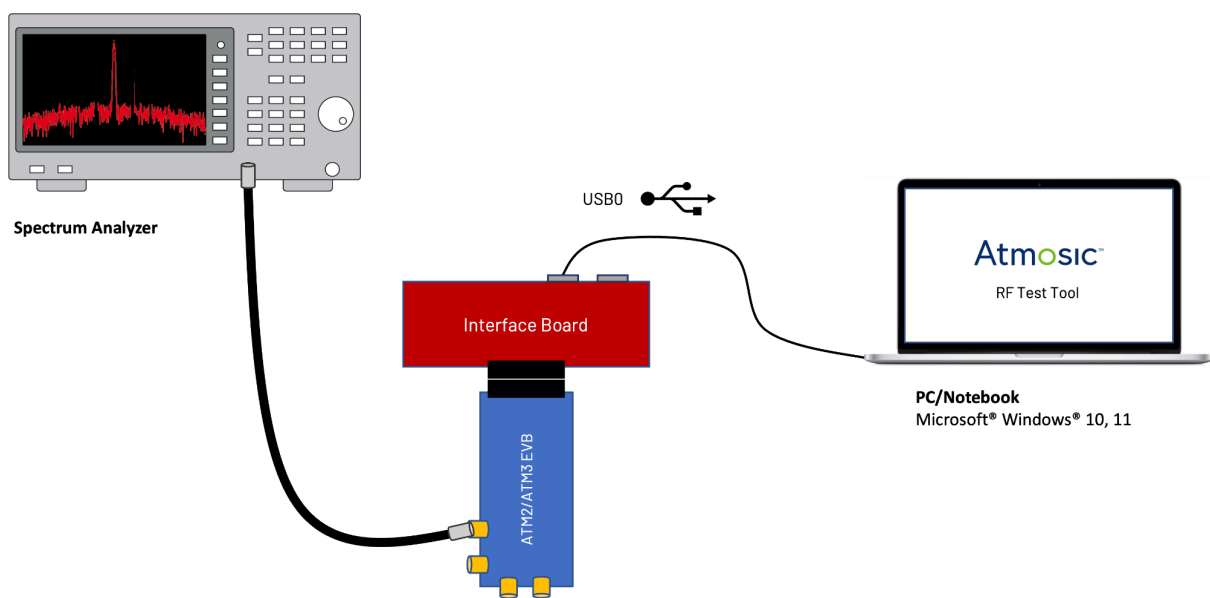

Figure 13 - ATM2/ATM3 EVK Tx Test Environment Setting

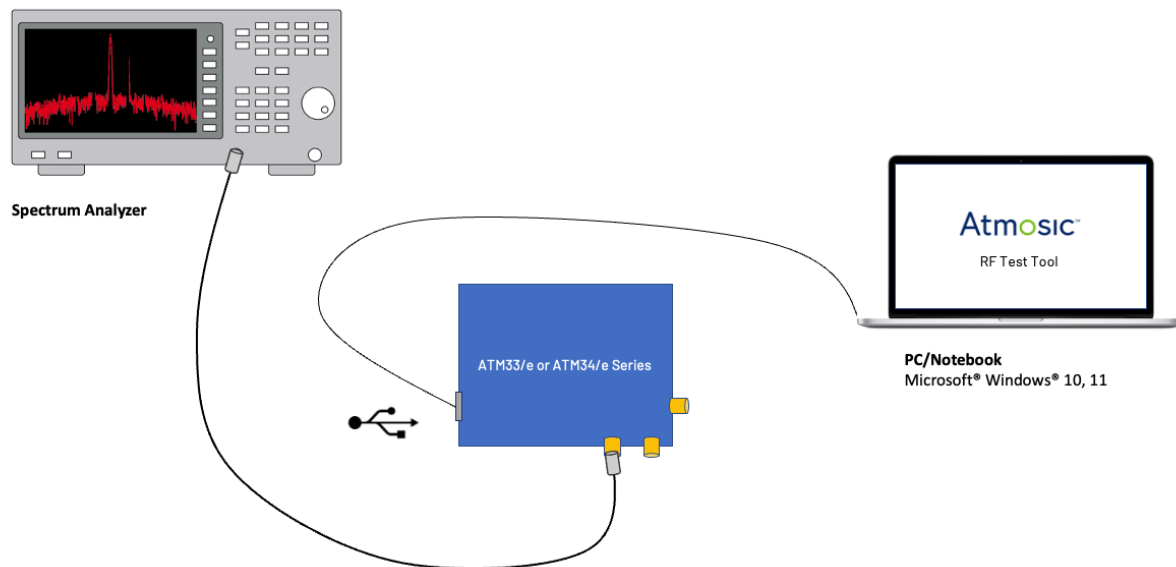

Figure 14 - ATM33/e or ATM34/e EVK Tx Test Environment Setting

3.1.1 Burst Tx Mode

In the default setting, when TxTest is selected, the burst-type modulation signal (duty cycle) will be sent to the RF port. Select an RF channel, RF PHY, Tx power level, and data length before pressing the TxTest button.

To change the transmission settings, first press StopTx to stop the RF signal transmission, then select a new transmission setting.

3.1.2 Infinite Tx Mode

- Select Enable Infinite to enable the Infinite Tx mode. When TxTest is selected, the continuous modulation signal (endless packet) will be sent to the RF port.
- Select an RF channel, RF PHY, Tx power level, and data length before pressing the TxTest button.
- To change the transmission settings, first press StopTx to stop the RF signal transmission, then select a new transmission setting.

3.1.3 Single-Tone Transmission

- Select the PHY setting and choose *Single Tone*. When TxTest is selected, the continuous single tone without modulation signal will be sent to the RF port.
- Select an RF channel and Tx power level before pressing the TxTest button.
- To change the transmission settings, first press StopTx to stop the RF signal transmission, then select a new transmission setting.

3.2 Rx Test

3.2.1 Rx Mode

- Select RxTest to enable the Rx mode.
- Select an RF channel, RF PHY before pressing the RxTest button.
- To change the Rx settings, first press StopRx to disable the Rx mode, then select new Rx settings.

4. Check the DUT RF Function Using the RF Test Tool

To check the Device Under Test (DUT) RF function without a Bluetooth LE tester, prepare a reference unit such as ATM3330e EVK and DUT.

Open two instances of RF Test Tool on the same PC, then control the reference unit and DUT on each instance separately.

[Figure 15](#) and [Figure 16](#) illustrate the test environments for the ATM2/ATM3, ATM33/e, and ATM34/e respectively.

Set the reference unit into Burst Tx mode to verify the DUT in Rx mode. Then swap the test to set the reference unit into Rx mode to verify the DUT in Burst Tx mode.

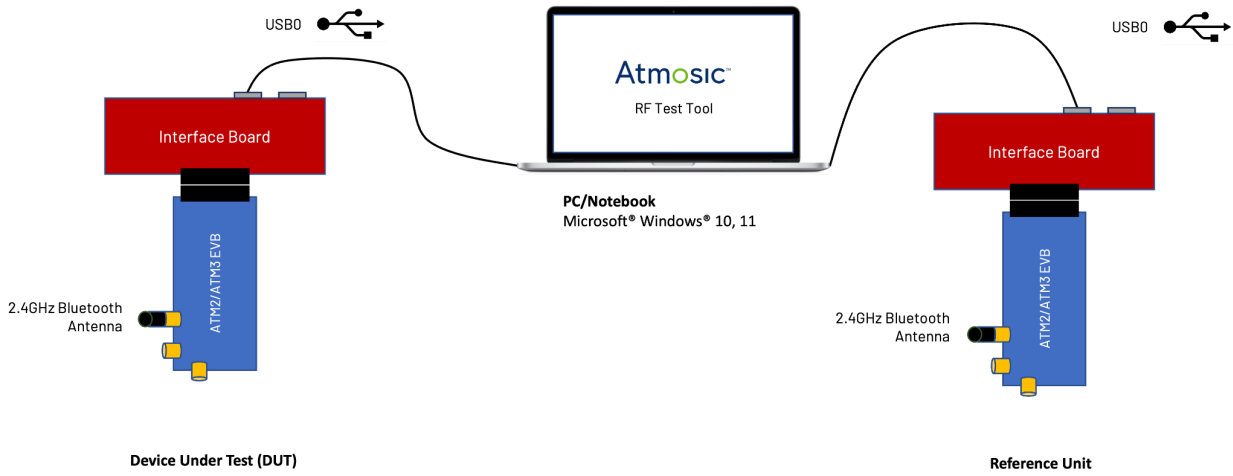

Figure 15 - Test Environment to Check DUT RF Function Using RF Test Tool for the ATM2/ATM3

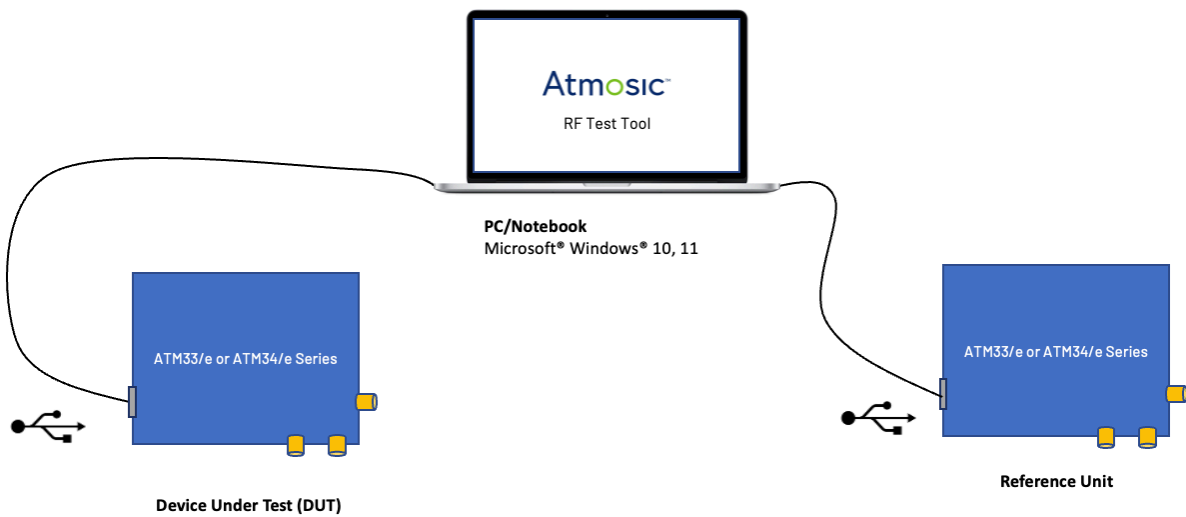

Figure 16 - Test Environment to Check DUT RF Function Using RF Test Tool for the ATM33/e or ATM34/e

5. 16 MHz Crystal Calibration Using RF Test Tool

The 16 MHz crystal is used in Bluetooth LE devices. Bluetooth devices use a crystal oscillator to generate a stable reference frequency for the system clock. The crystal's frequency needs to be accurately calibrated to ensure that the Bluetooth device's radio signals are transmitted and received at the correct frequency.

This tool also provides a feature to aid the calibration flow. The setup is the same environment as the Tx Test section. Enter the CAL. page in the tool, input the channel you would like to calibrate, and the tool will pop a window to guide you through the process. You may need to input the frequency bias you observe from the spectrum analyzer in several iterations. See [Figure 17](#).

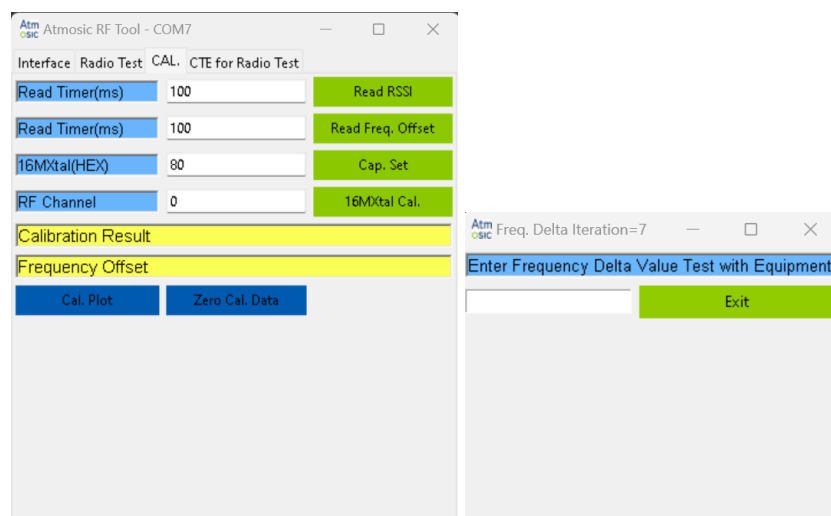

Figure 17 - Calibration iterations in RF Tool

Once the iterations are done, if you are satisfied with the calibration result, you can write back the calibration adjustment parameter the tool suggests by inputting the value and clicking Cap. Set. See [Figure 18](#).

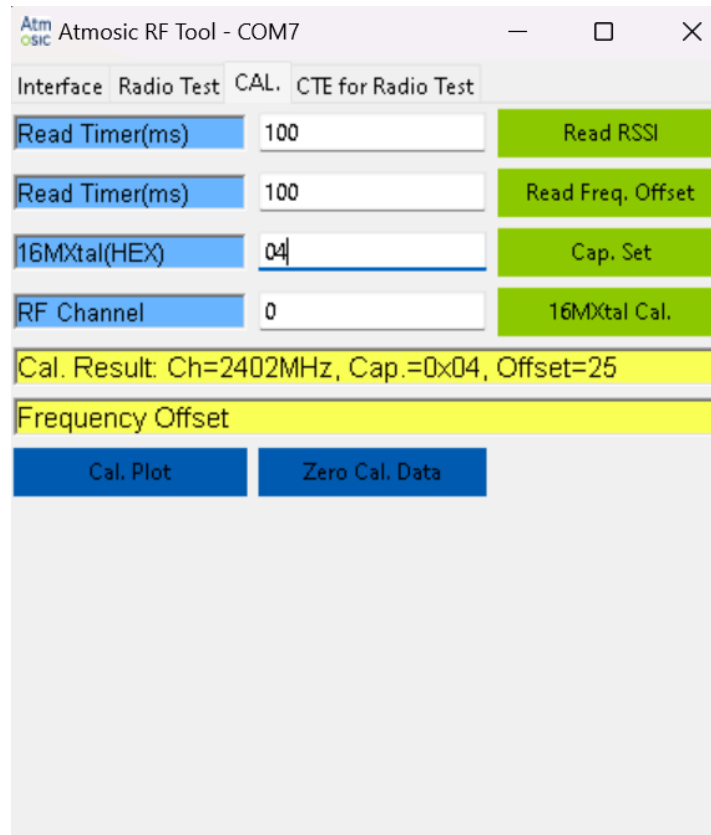

Figure 18 - Calibration result in RF Tool

6. ATM34/e 802.15.4 RF Test

For the ATM34/e 802.15.4 RF Test, please use the CHCI example included in the Atmosic SDK. The baud rate should be selected as 2000000 for the default setting. See [Figure 19](#).

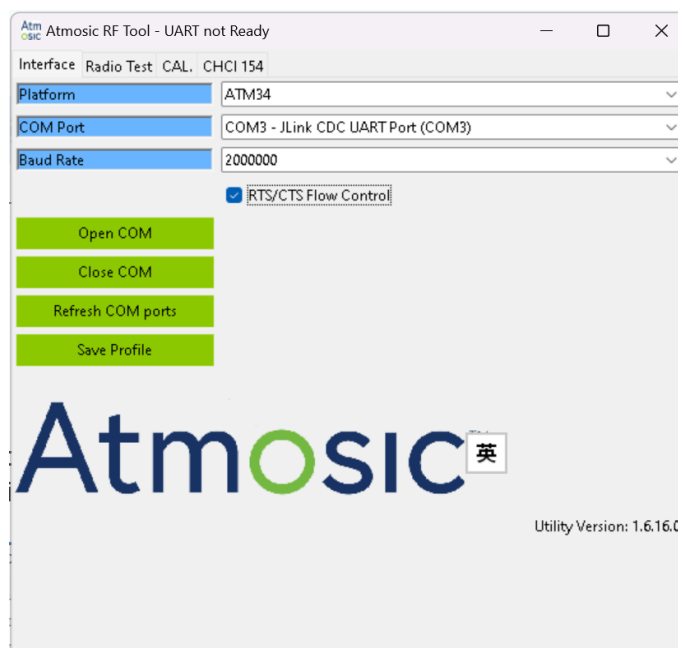

Figure 19 - Configure baud rate for ATM34/e CHCI firmware

Select the CHCI 154 in the top tab bar to enter the test interface. See [Figure 20](#).

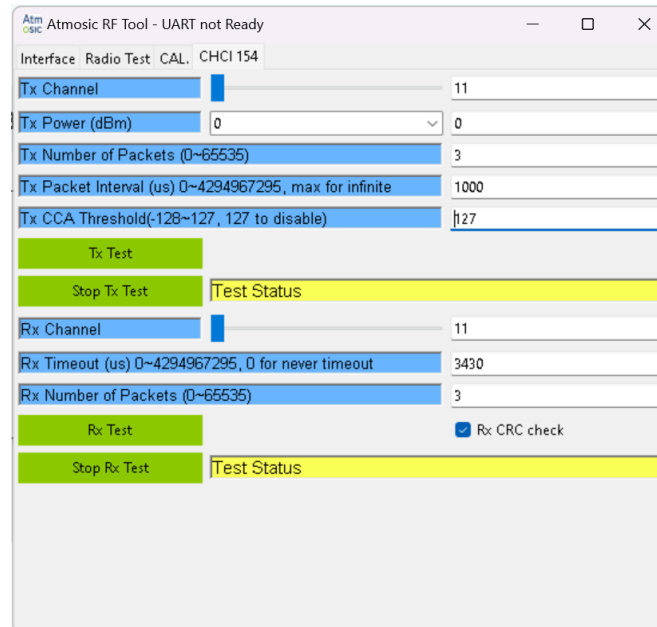

Figure 20 - CHCI RF Test interface

To set up the test without using external equipment, use two ATM34/e boards as the transmitter source and receiver. Open one RF Tool process and configure one board as a Tx source, and another for an Rx receiver. See [Figure 21](#). Start by clicking on the Rx test button for the Rx receiver and then click on the Tx Test button on the Tx source. Click Stop Rx Test and Stop Tx Test, and observe the packet success and packet error counts to see if the counts match the configured number of packets.

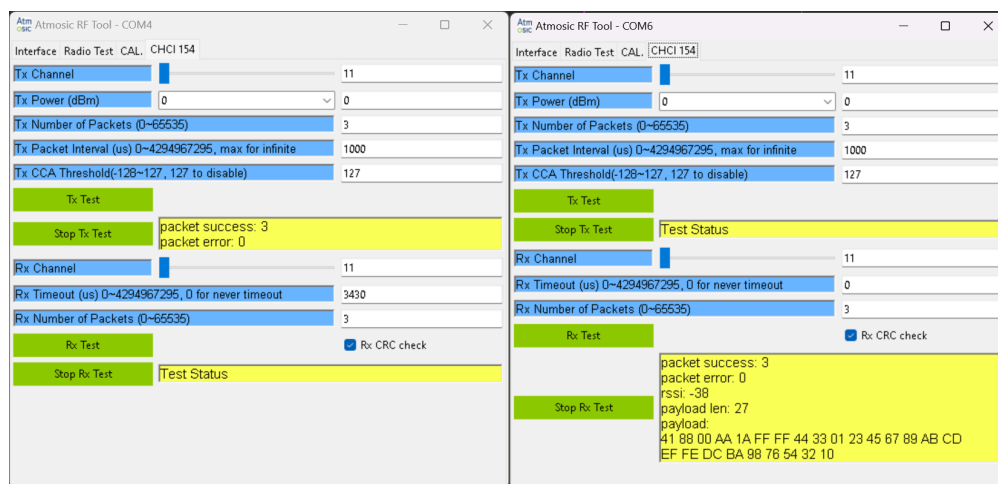

Figure 21 - CHCI Rx/Tx pair test with two boards

References

Title	Document Number
EVK User's Guide for ATMx301/ATMx202	ATMx201-UG
EVK User's Guide for ATMx221	ATMx221-UG
ATM33/e Series Evaluation Kit User Guide	ATM33_e-UGEVK
	Link
Zadig Driver	Version 2.4

Revision History

Date	Version	Description
April 22, 2024	0.62	Update for RF Tool version 1.6.16.1. Remove plotting Rx NOP statistics and support ATM34/e 802.15.4 RF Test.
March 17, 2023	0.60	Updated for RF Tool version 1.6.5. Updated Table 2 - Supported ATM33/e SoCs and EVKs , Setup Software , Install WinUSB Driver Using Zadig , Program Firmware , UART Ports , Burst Tx Mode , Infinite Tx Mode , added 16 MHz Crystal Calibration Using RF Test Tool sections.
March 21, 2022	0.54	Updated for RF Tool version 1.6.0. throughout this document.
August 23, 2021	0.53	Updated baud rate in Figure 10 - RF Test Tool Interface Setting .
April 14, 2021	0.52	Updated format, no content change.
December 2, 2020	0.51	Corrected typos.
June 15, 2020	0.50	Initial version created.



ATMOSIC TECHNOLOGIES – DISCLAIMER

This product document is intended to be a general informational aid and not a substitute for any literature or labeling accompanying your purchase of the Atmosic product. Atmosic reserves the right to amend its product literature at any time without notice and for any reason, including to improve product design or function. While Atmosic strives to make its documents accurate and current, Atmosic makes no warranty or representation that the information contained in this document is completely accurate, and Atmosic hereby disclaims (i) any and all liability for any errors or inaccuracies contained in any document or in any other product literature and any damages or lost profits resulting therefrom; (ii) any and all liability and responsibility for any action you take or fail to take based on the information contained in this document; and (iii) any and all implied warranties which may attach to this document, including warranties of fitness for particular purpose, non-infringement and merchantability. Consequently, you assume all risk in your use of this document, the Atmosic product, and in any action you take or fail to take based upon the information in this document. Any statements in this document in regard to the suitability of an Atmosic product for certain types of applications are based on Atmosic's general knowledge of typical requirements in generic applications and are not binding statements about the suitability of Atmosic products for any particular application. It is your responsibility as the customer to validate that a particular Atmosic product is suitable for use in a particular application. All content in this document is proprietary, copyrighted, and owned or licensed by Atmosic, and any unauthorized use of content or trademarks contained herein is strictly prohibited.

Copyright ©2020-2023 by Atmosic Technologies. All rights reserved. Atmosic logo is a registered trademark of Atmosic Technologies Inc. All other trademarks are the properties of their respective holders.



Atmosic Technologies | 2105 S. Bascom Ave. | Campbell CA, 95008
www.atmosic.com